

BP1600 Tech Sheet

Balboa Water Group

System Part Numbers: **56129-02** 3kW 800 Incoloy Element
 56130-02 3kW Titanium Element

Compatible Plumbing Kits (Coupling nuts and seals included)

55911	2" Tailpieces (2-Speed Pump 1)
55914	1.5" Tailpieces (2-Speed Pump 1)
55912	1" Tailpiece Inserts (Circ)
55913	One Direct Circ Pump Coupling and one 1" Tailpiece Insert

CE System Model: BP16-BP1600-RCA-3.0KW
Software ID: M100_205 V6
Software Version: 6.0
Hex File: BP1600_6.0_BP16TP4.hex
Configuration Signature: EDD8C3A4

Eng. Project: 3767

Base PCBs / PCBA's:

Power Board: 22117_B / 56132
Logic Board: 22121_E / 56131-02

Control Panels:

TP600CE	50014-01
TP600 (non-CE) should not be used	
Software Version	2.3 and later
TP400T	50260
Software Version	2.4 and later
TP400W	50259
Software Version	2.4 and later

Auxiliary Panels

AX10A2 55919



User Interface and Programming Guide:
http://service.balboa-instruments.com/zz40940_download.zip



Manufactured under one or more of these patents. U.S. Patents: 5332944, 5361215, 5550753, 5559720, 5,883,459, 6253227, 6282370, 6590188, 6976052, 6965815, 7030343, 7,417,834 b2, Canadian Patent: 2342614, Australian patent: 2373248 other patents both foreign and domestic applied for and pending. All material copyright of Balboa Water Group.

System Revision History

Part #	EPN	Date	Originator	Changes Made
55746 and 55748	3351	03-09-10	Balboa	Initial Generic Configuration 800 Incoloy and Titanium models Initial release
55746-01 and 55748-01	3479	10-11-10	BWG	RMA Tester and eFAST compatibility added. Transformer Update
55629 and 55630	N/A	03-03-11	BWG	Fix typo on setups with Misc output
56129 and 56130	N/A	08-04-11	BWG	Part number corrections
56129-01 and 56130-01	N/A	09-14-11	BWG	TP400 support, Auto Linking, Set Time moved to menu
56129-01 and 56130-01	3767	01-10-12	BWG	Add iPhone App support.



Plumbing Fittings



2" Tailpiece kit PN 55911.

Standard 2" sockets to glue up to 2" PVC pipe.



Not Immediately Available.

1.5" Tailpiece kit PN 55914.

1.5" sockets to glue up to 1.5" PVC pipe with the I.D.

Be sure to orient the fittings so that the insert is at the 12:00 position to prevent trapped air.



1" Circ Pump Insert kit PN 55912.

1" barb fittings for use with 1" tubing.

Be sure to orient the fittings so that the insert is at the 12:00 position to prevent trapped air.



Not Immediately Available.

1" Circ Pump Insert kit PN 55913.

One fitting for direct coupling to the threaded suction of an appropriately-sized circ pump. A 1" barb fitting for use with 1" tubing is used on the other end of the heater.

Be sure to orient the fittings so that the insert is at the 12:00 position to prevent trapped air.



Setup 1-16 – As Manufactured

Power Requirements:

Single Service [3 wires (line, neutral, ground)]
 230VAC, 50Hz, 1p, 16A, (Circuit Breaker rating = 20A max.)

System Outputs - 16A Service:

Pump 1	230VAC	2-Speed	7.5A max	30-minute timer for Low Speed, 15 Minutes for High Speed
				This is the heater pump Must deliver a minimum of 20 GPM through heater Low Speed may not exceed 2A max
Pump 2	230VAC	1-Speed	7.5A max	15-minute timer
Ozone	230VAC		.5A max	Uses the same relay as Pump 1 Low
Spa Light	10VAC	On/Off	1A max	4-Hour timer.
Heater	3kW @ 240VAC			

Wiring Diagram and Settings

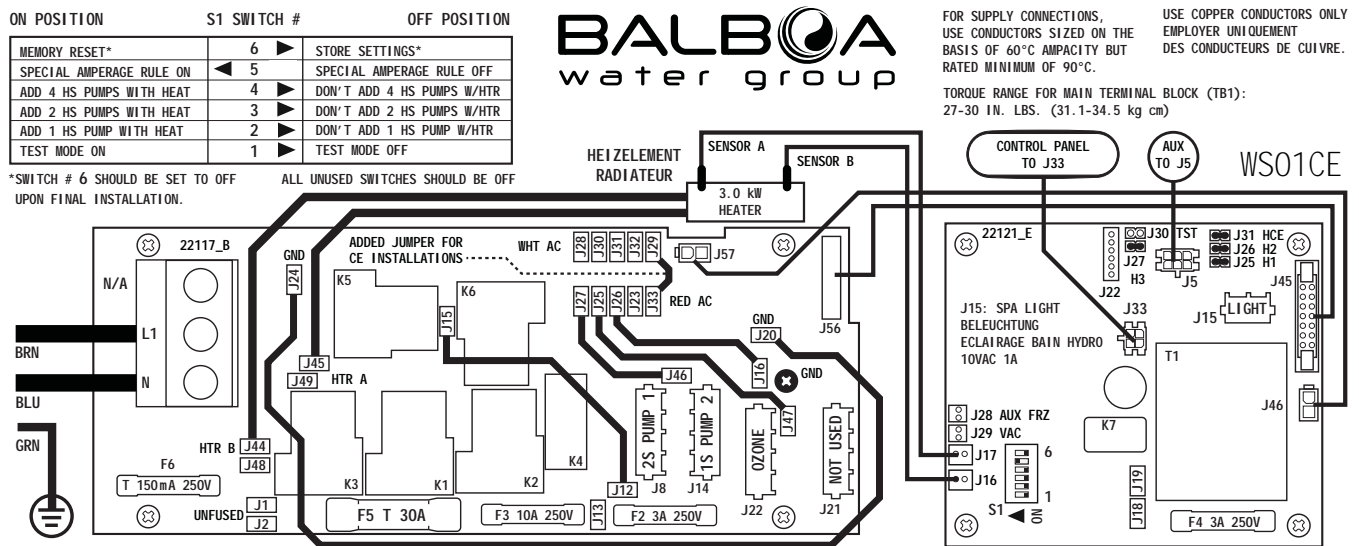

DIP Switch Option

Orig. Setup 1

Changes to

Special Amperage Rule ON DIP Switch 5 OFF *DIP Switch 5 ON*

Use this only in cases where there is an overcurrent condition due to pump size.

This setting will not allow Pump 1 High and Pump 2 to run at the same time.



Refer to Page 3 to choose a suitable Plumbing Kit.

Setup 1-32

Power Requirements:

Single Service [3 wires (line, neutral, ground)]
 230VAC, 50Hz, 1p, 32A, (Circuit Breaker rating = 40A max.)

System Outputs - 32A Service:

Pump 1	230VAC	2-Speed	12A max	30-minute timer for Low Speed, 15 Minutes for High Speed
This is the heater pump Must deliver a minimum of 20 GPM through heater				
Pump 2	230VAC	1-Speed	12A max	15-minute timer
Ozone	230VAC		.5A max	Uses the same relay as Pump 1 Low
Spa Light	10VAC	On/Off	1A max	4-Hour timer.
Heater	3kW @ 240VAC			
Misc.	J2 & J32	230VAC	4A max	Hot output (Stereo). Fused equipment or in-line fuse required.

Wiring Diagram and Settings

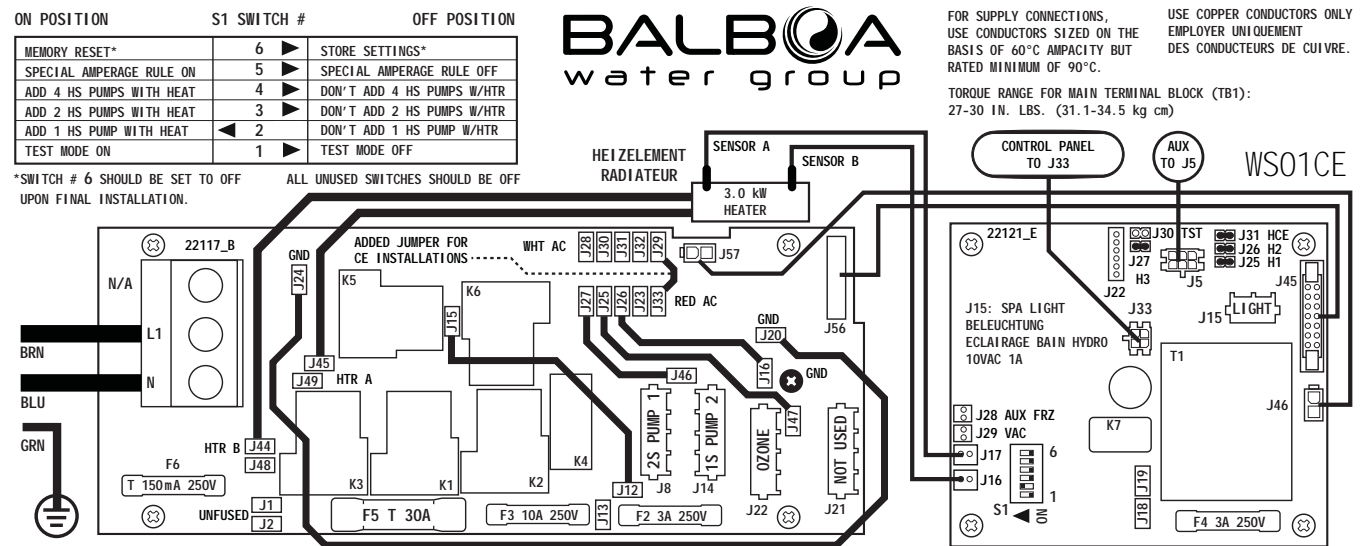

Configuration Changes based on Default Feature

Feature	Orig. Setup 1	Changes to
J2 & J32	Hot Output	Useable
DIP Switch Option	Orig. Setup 1	Changes to
Add 1 High Speed Pump with Heat	DIP Switch 2 OFF	DIP Switch 2 ON

Refer to Page 3 to choose a suitable Plumbing Kit.



Setup 2-16

Power Requirements:

Single Service [3 wires (line, neutral, ground)]
230VAC, 50Hz, 1p, 16A, (Circuit Breaker rating = 20A max.)

System Outputs - 16A Service:

Pump 1	230VAC	1-Speed	6.5A max	15-minute timer
Pump 2	230VAC	1-Speed	6.5A max	15-minute timer
Circ Pump	230VAC	1-Speed	2A max	Programmable Filtration Cycles + Polling
This is the heater pump Must deliver a minimum of 20 GPM through heater				
Ozone	230VAC		.5A max	Uses the same relay as the Circ Pump
Spa Light	10VAC	On/Off	1A max	4-Hour timer.
Heater	3kW @ 240VAC			

Wiring Diagram and Settings

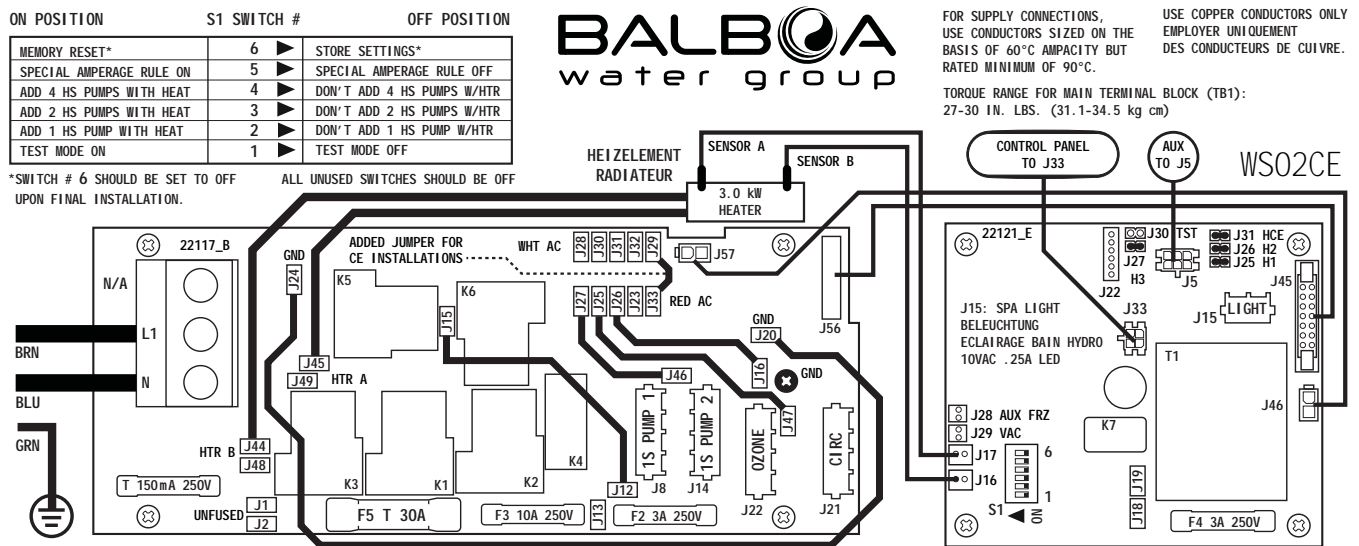

Configuration Changes based on Default Feature

Feature	Orig. Setup 1	Changes to
J8	2-Speed Pump 1	1-Speed Pump 1
J21	Not Used (non-circ)	Circ Pump Enabled

Refer to Page 3 to choose a suitable Plumbing Kit.

Blue indicates changes from the original Setup 1 default

Manufactured under one or more of these patents. U.S. Patents: 5332944, 5361215, 5550753, 5559720, 5,883,459, 6253227, 6282370, 6590188, 6976052, 6965815, 7030343, 7,417,834 b2, Canadian Patent: 2342614, Australian patent: 2373248 other patents both foreign and domestic applied for and pending. All material copyright of Balboa Water Group.

Setup 2-32

Power Requirements:

Single Service [3 wires (line, neutral, ground)]
230VAC, 50Hz, 1p, 32A, (Circuit Breaker rating = 40A max.)

System Outputs - 32A Service:

Pump 1	230VAC	1-Speed	12A max	15-minute timer
Pump 2	230VAC	1-Speed	12A max	15-minute timer
Circ Pump	230VAC	1-Speed	2A max	Programmable Filtration Cycles + Polling
This is the heater pump Must deliver a minimum of 20 GPM through heater				
Ozone	230VAC		.5A max	Uses the same relay as the Circ Pump
Spa Light	10VAC	On/Off	1A max	4-Hour timer.
Heater	3kW @ 240VAC			
Misc.	J2 & J32	230VAC	3A max	Hot output (Stereo). Fused equipment or in-line fuse required.

Wiring Diagram and Settings

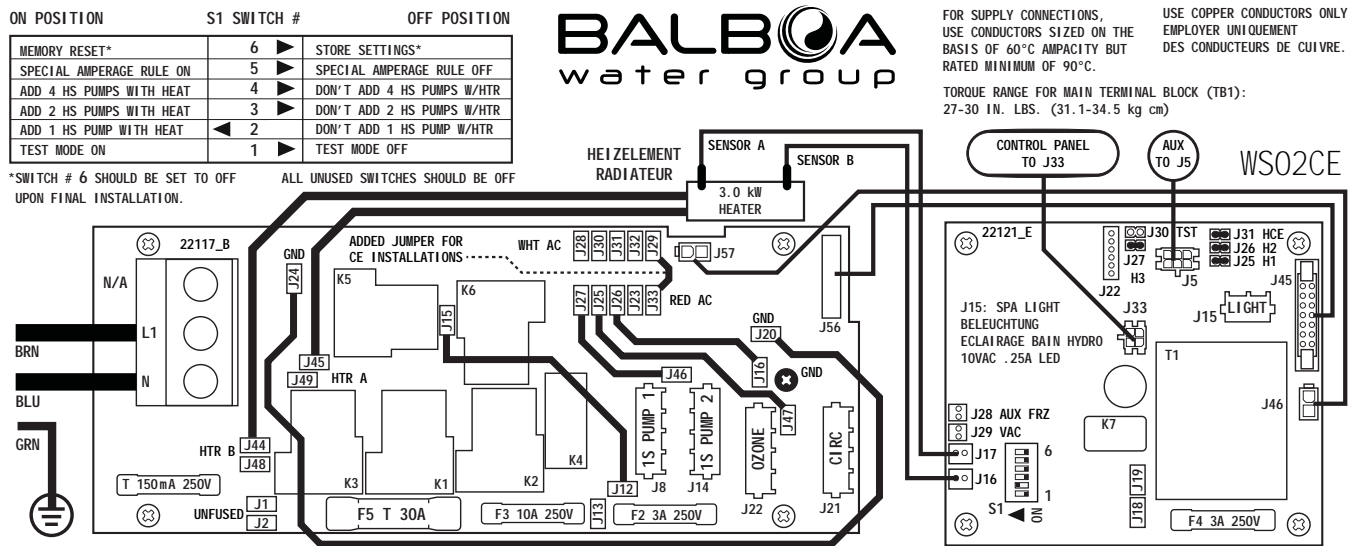

Configuration Changes based on Default Feature

Feature	Orig. Setup 1	Changes to
J8	2-Speed Pump 1	<i>1-Speed Pump 1</i>
J21	Not Used (non-circ)	<i>Circ Pump Enabled</i>
J2 & J32	Hot Output	<i>Useable</i>

DIP Switch Option

Add 1 High Speed Pump with Heat DIP Switch 2 OFF *DIP Switch 2 ON*

Refer to Page 3 to choose a suitable Plumbing Kit.

Blue indicates changes from the original Setup 1 default

Manufactured under one or more of these patents. U.S. Patents: 5332944, 5361215, 5550753, 5559720, 5,883,459, 6253227, 6282370, 6590188, 6976052, 6965815, 7030343, 7,417,834 b2, Canadian Patent: 2342614, Australian patent: 2373248 other patents both foreign and domestic applied for and pending. All material copyright of Balboa Water Group.



Setup 3-16

Power Requirements:

Single Service [3 wires (line, neutral, ground)]
 230VAC, 50Hz, 1p, 16A, (Circuit Breaker rating = 20A max.)

System Outputs - 16A Service:

Pump 1	230VAC	2-Speed	10A max	30-minute timer for Low Speed, 15 Minutes for High Speed
				This is the heater pump Must deliver a minimum of 20 GPM through heater Low Speed may not exceed 2A max
Blower	230VAC	1-Speed	4A max	15-minute timer
Ozone	230VAC		.5A max	Uses the same relay as Pump 1 Low
Spa Light	10VAC	On/Off	1A max	4-Hour timer.
Heater	3kW @ 240VAC			

Wiring Diagram and Settings

ON POSITION	S1 SWITCH #	OFF POSITION
MEMORY RESET*	6	STORE SETTINGS*
SPECIAL AMPERAGE RULE ON	5	SPECIAL AMPERAGE RULE OFF
ADD 4 HS PUMPS WITH HEAT	4	DON'T ADD 4 HS PUMPS W/HTR
ADD 2 HS PUMPS WITH HEAT	3	DON'T ADD 2 HS PUMPS W/HTR
ADD 1 HS PUMP WITH HEAT	2	DON'T ADD 1 HS PUMP W/HTR
TEST MODE ON	1	TEST MODE OFF

*SWITCH # 6 SHOULD BE SET TO OFF UPON FINAL INSTALLATION. ALL UNUSED SWITCHES SHOULD BE OFF



FOR SUPPLY CONNECTIONS, USE COPPER CONDUCTORS ONLY
 USE CONDUCTORS SIZED ON THE BASIS OF 60°C AMPACITY BUT RATED MINIMUM OF 90°C.
 EMPLOYER UNIQUEMENT DES CONDUCTEURS DE CUIVRE.
 TORQUE RANGE FOR MAIN TERMINAL BLOCK (TB1):
 27-30 I.N. LBS. (31.1-34.5 kg cm)

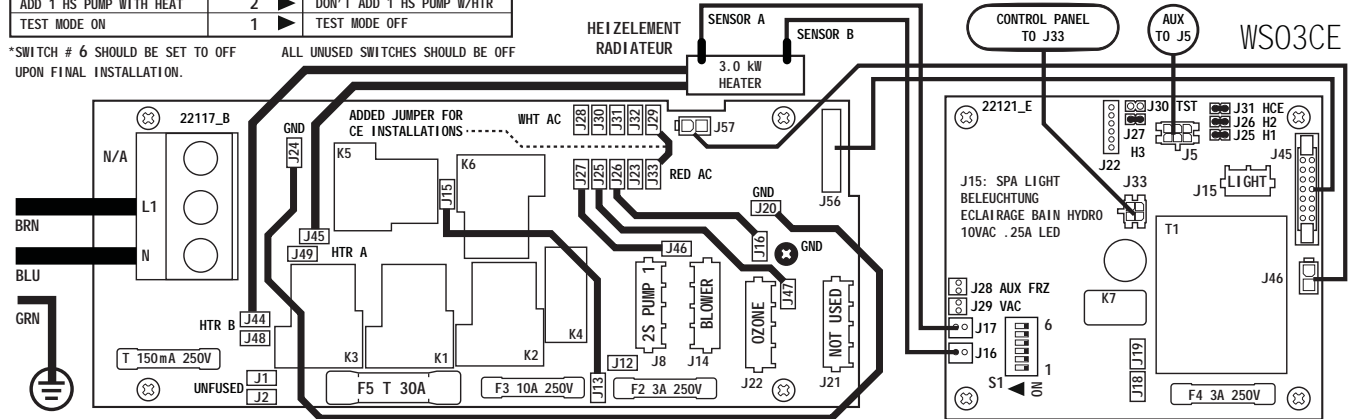

Configuration Changes based on Default Feature

Feature	Orig. Setup 1	Changes to
J14, TP600 Button 2, TP400 Button 4, LED 2, AX10A2	Pump 2	Blower

Refer to Page 3 to choose a suitable Plumbing Kit.

Blue indicates changes from the original Setup 1 default

Manufactured under one or more of these patents. U.S. Patents: 5332944, 5361215, 5550753, 5559720, 5,883,459, 6253227, 6282370, 6590188, 6976052, 6965815, 7030343, 7,417,834 b2, Canadian Patent: 2342614, Australian patent: 2373248 other patents both foreign and domestic applied for and pending. All material copyright of Balboa Water Group.



Setup 3-32

Power Requirements:

Single Service [3 wires (line, neutral, ground)]
230VAC, 50Hz, 1p, 32A, (Circuit Breaker rating = 40A max.)

System Outputs - 32A Service:

Pump 1	230VAC	2-Speed	12A max	30-minute timer for Low Speed, 15 Minutes for High Speed
This is the heater pump Must deliver a minimum of 20 GPM through heater				
Blower	230VAC	1-Speed	4A max	15-minute timer
Ozone	230VAC		.5A max	Uses the same relay as Pump 1 Low
Spa Light	10VAC	On/Off	1A max	4-Hour timer.
Heater	3kW @ 240VAC			
Misc.	J2 & J32	230VAC	3A max	Hot output (Stereo). Fused equipment or in-line fuse required.

Wiring Diagram and Settings

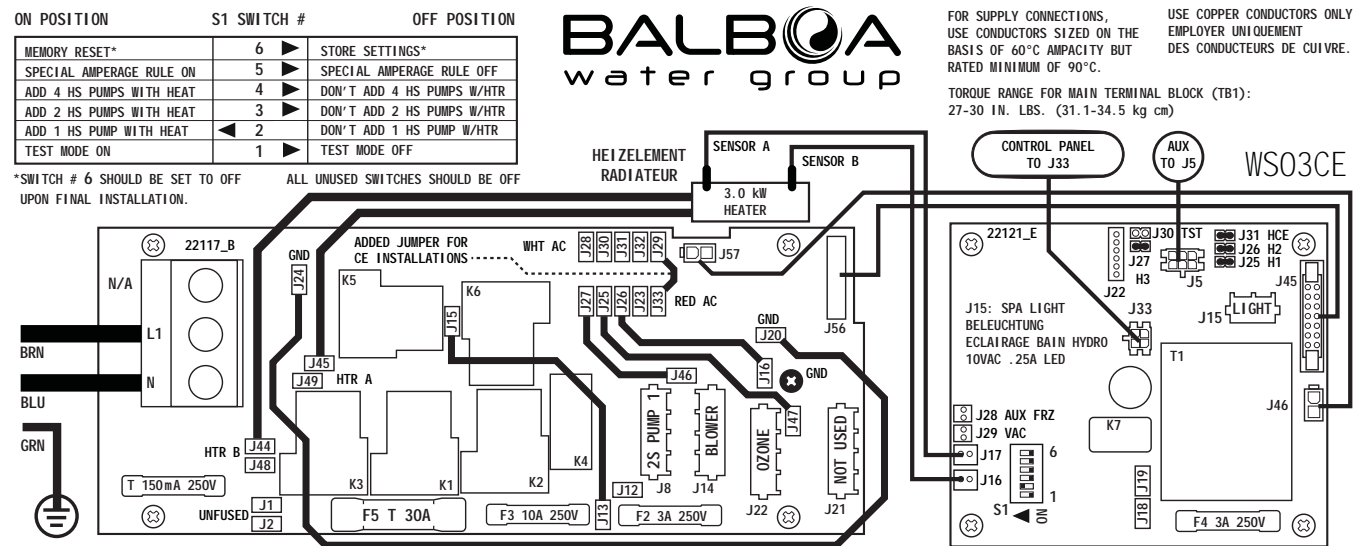

Configuration Changes based on Default Feature

Feature	Orig. Setup 1	Changes to
J14, TP600 Button 2, TP400 Button 4, LED 2, AX10A2	Pump 2	Blower
J2 & J32	Hot Output	Useable
DIP Switch Option		
Add 1 High Speed Pump with Heat	DIP Switch 2 OFF	DIP Switch 2 ON

Refer to Page 3 to choose a suitable Plumbing Kit.

Blue indicates changes from the original Setup 1 default

Manufactured under one or more of these patents. U.S. Patents: 5332944, 5361215, 5550753, 5559720, 5,883,459, 6253227, 6282370, 6590188, 6976052, 6965815, 7030343, 7,417,834 b2, Canadian Patent: 2342614, Australian patent: 2373248 other patents both foreign and domestic applied for and pending. All material copyright of Balboa Water Group.



Setup 4-16

Power Requirements:

Single Service [3 wires (line, neutral, ground)]
 230VAC, 50Hz, 1p, 16A, (Circuit Breaker rating = 20A max.)

System Outputs - 16A Service:

Pump 1	230VAC	1-Speed	8A max	15-minute timer
Blower	230VAC	1-Speed	4A max	15-minute timer
Circ Pump	230VAC	1-Speed	2A max	Programmable Filtration Cycles + Polling
This is the heater pump Must deliver a minimum of 20 GPM through heater				
Ozone	230VAC		.5A max	Uses the same relay as the Circ Pump
Spa Light	10VAC	On/Off	1A max	4-Hour timer.
Heater	4kW @ 240VAC			

Wiring Diagram and Settings

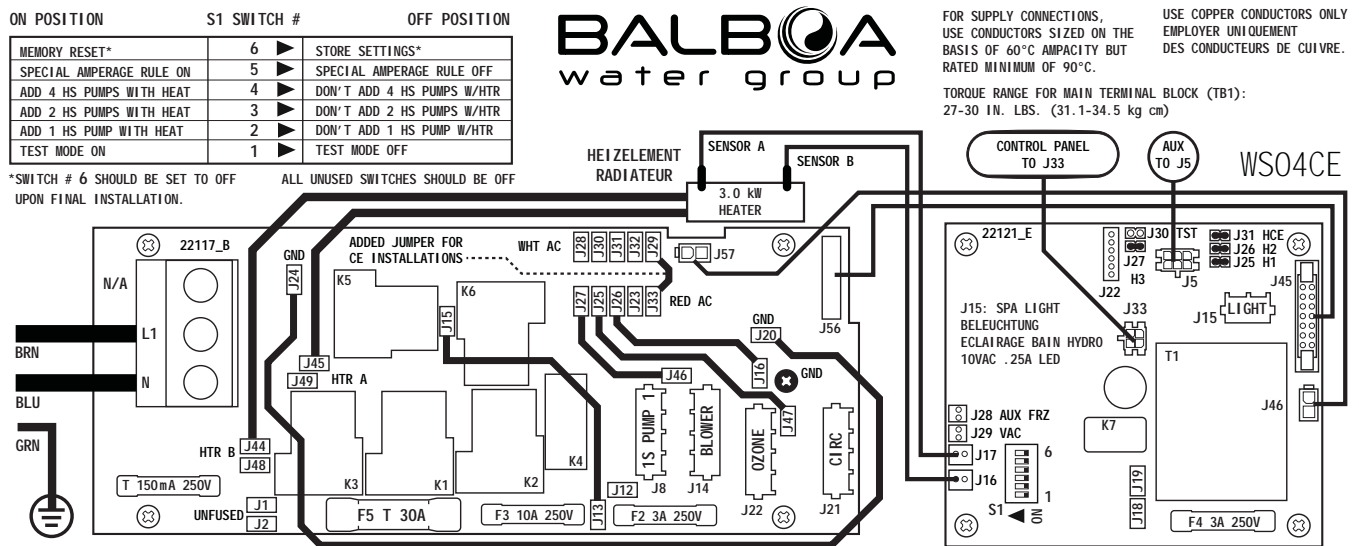

Configuration Changes based on Default Feature

Feature	Orig. Setup 1	Changes to
J8	2-Speed Pump 1	<i>1-Speed Pump 1</i>
J14, TP600 Button 2, TP400 Button 4, LED 2, AX10A2	Pump 2	<i>Blower</i>
J21	Not Used (non-circ)	<i>Circ Pump Enabled</i>

Refer to Page 3 to choose a suitable Plumbing Kit.

Blue indicates changes from the original Setup 1 default



Manufactured under one or more of these patents. U.S. Patents: 5332944, 5361215, 5550753, 5559720, 5,883,459, 6253227, 6282370, 6590188, 6976052, 6965815, 7030343, 7,417,834 b2, Canadian Patent: 2342614, Australian patent: 2373248 other patents both foreign and domestic applied for and pending. All material copyright of Balboa Water Group.

Setup 4-32

Power Requirements:

Single Service [3 wires (line, neutral, ground)]
230VAC, 50Hz, 1p, 32A, (Circuit Breaker rating = 40A max.)

System Outputs - 32A Service:

Pump 1	230VAC	1-Speed	12A max	15-minute timer
Blower	230VAC	1-Speed	4A max	15-minute timer
Circ Pump	230VAC	1-Speed	2A max	Programmable Filtration Cycles + Polling
This is the heater pump Must deliver a minimum of 20 GPM through heater				
Ozone	230VAC		.5A max	Uses the same relay as the Circ Pump
Spa Light	10VAC	On/Off	1A max	4-Hour timer.
Heater	4kW @ 240VAC			
Misc.	J2 & J32	230VAC	4A max	Hot output (Stereo). Fused equipment or in-line fuse required.

Wiring Diagram and Settings

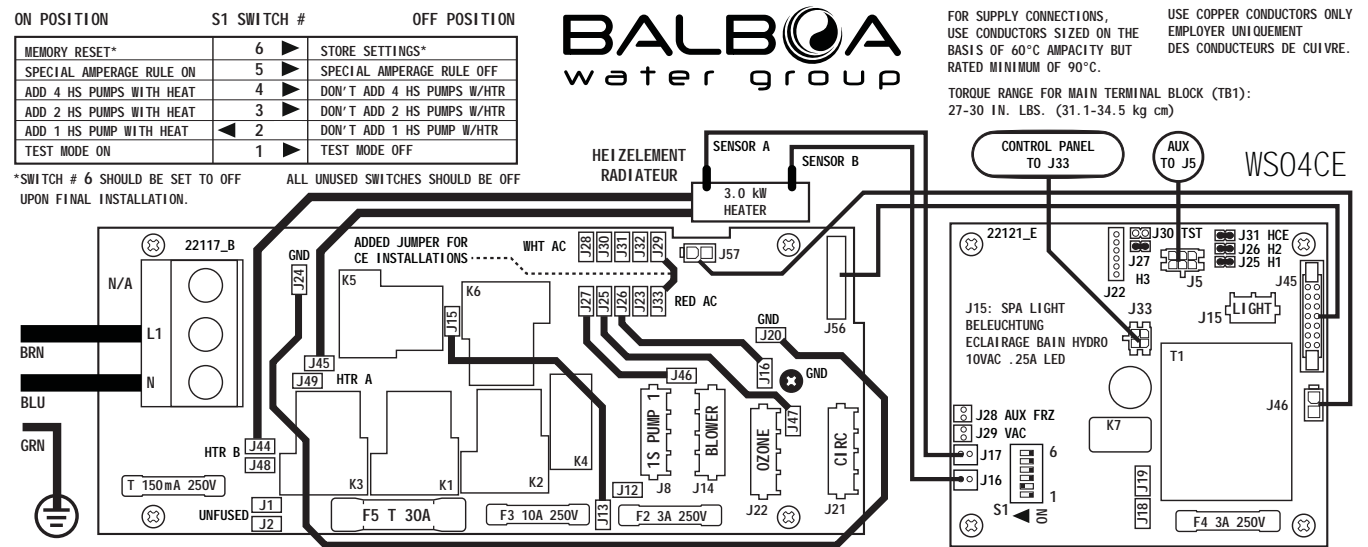

Software Configuration Changes based on Default Feature

Feature	Orig. Setup 1	Changes to
J8	2-Speed Pump 1	<i>1-Speed Pump 1</i>
J14, TP600 Button 2, TP400 Button 4, LED 2, AX10A2	Pump 2	<i>Blower</i>
J21	Not Used (non-circ)	<i>Circ Pump Enabled</i>
J2 & J32	Hot Output	<i>Useable</i>

Refer to Page 3 to choose a suitable Plumbing Kit.

Blue indicates changes from the original Setup 1 default

Manufactured under one or more of these patents. U.S. Patents: 5332944, 5361215, 5550753, 5559720, 5,883,459, 6253227, 6282370, 6590188, 6976052, 6965815, 7030343, 7,417,834 b2, Canadian Patent: 2342614, Australian patent: 2373248 other patents both foreign and domestic applied for and pending. All material copyright of Balboa Water Group.

Setup 5-16

Power Requirements:

Single Service [3 wires (line, neutral, ground)]
 230VAC, 50Hz, 1p, 16A, (Circuit Breaker rating = 20A max.)

System Outputs - 16A Service:

Pump 1	230VAC	2-Speed	12A max	30-minute timer for Low Speed, 15 Minutes for High Speed
		This is the heater pump		
		Must deliver a minimum of 20 GPM through heater		
		Low Speed may not exceed 2A max		
Ozone	230VAC		.5A max	Uses the same relay as Pump 1 Low
Spa Light	10VAC	On/Off	1A max	4-Hour timer.
Heater	3kW @ 240VAC			

Wiring Diagram and Settings

ON POSITION	S1 SWITCH #	OFF POSITION
MEMORY RESET*	6	STORE SETTINGS*
SPECIAL AMPERAGE RULE ON	5	SPECIAL AMPERAGE RULE OFF
ADD 4 HS PUMPS WITH HEAT	4	DON'T ADD 4 HS PUMPS W/HTR
ADD 2 HS PUMPS WITH HEAT	3	DON'T ADD 2 HS PUMPS W/HTR
ADD 1 HS PUMP WITH HEAT	2	DON'T ADD 1 HS PUMP W/HTR
TEST MODE ON	1	TEST MODE OFF

*SWITCH # 6 SHOULD BE SET TO OFF UPON FINAL INSTALLATION. ALL UNUSED SWITCHES SHOULD BE OFF



FOR SUPPLY CONNECTIONS, USE COPPER CONDUCTORS ONLY
 USE CONDUCTORS SIZED ON THE BASIS OF 60°C AMPACITY BUT RATED MINIMUM OF 90°C.
 EMPLOYER UNIQUEMENT DES CONDUCTEURS DE CUIVRE.
 TORQUE RANGE FOR MAIN TERMINAL BLOCK (TB1):
 27-30 IN. LBS. (31.1-34.5 kg cm)

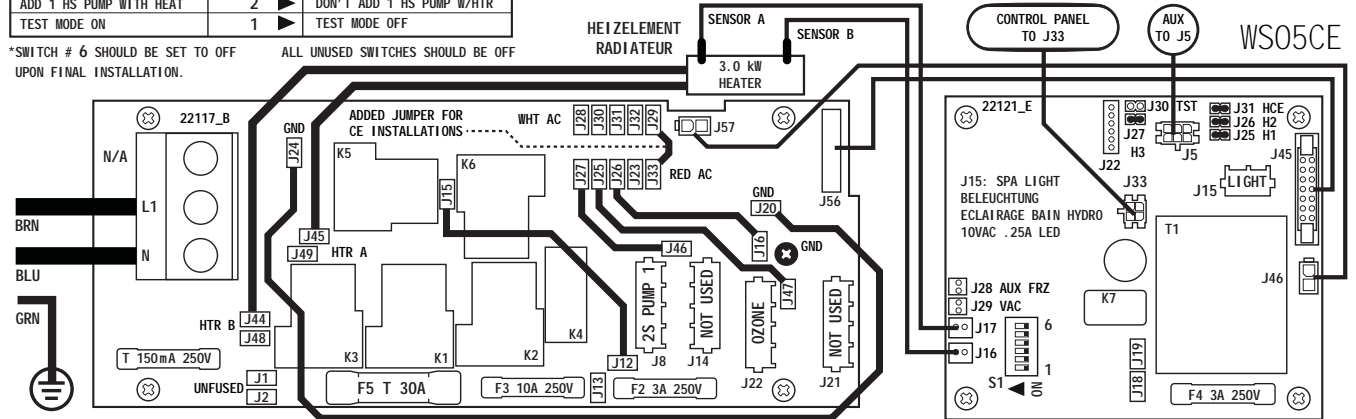

Software Configuration Changes based on Default Feature

Feature	Orig. Setup 1	Changes to
J14, TP600 Button 2, TP400 Button 4, LED 2, AX10A2	Pump 2	Not Used

Refer to Page 3 to choose a suitable Plumbing Kit.

Blue indicates changes from the original Setup 1 default



Manufactured under one or more of these patents. U.S. Patents: 5332944, 5361215, 5550753, 5559720, 5,883,459, 6253227, 6282370, 6590188, 6976052, 6965815, 7030343, 7,417,834 b2, Canadian Patent: 2342614, Australian patent: 2373248 other patents both foreign and domestic applied for and pending. All material copyright of Balboa Water Group.

Setup 5-32

Power Requirements:

Single Service [3 wires (line, neutral, ground)]
230VAC, 50Hz, 1p, 32A, (Circuit Breaker rating = 40A max.)

System Outputs - 32A Service:

Pump 1	230VAC	2-Speed	12A max	30-minute timer for Low Speed, 15 Minutes for High Speed
	This is the heater pump			
	Must deliver a minimum of 20 GPM through heater			
Ozone	230VAC		.5A max	Uses the same relay as Pump 1 Low
Spa Light	10VAC	On/Off	1A max	4-Hour timer.
Heater	3kW @ 240VAC			
Misc.	J2 & J32	230VAC	4A max	Hot output (Stereo). Fused equipment or in-line fuse required.

Wiring Diagram and Settings

ON POSITION	S1 SWITCH #	50A MAX SETTINGS	OFF POSITION
MEMORY RESET*	6	▶	STORE SETTINGS*
SPECIAL AMPERAGE RULE ON	5	▶	SPECIAL AMPERAGE RULE OFF
ADD 4 HS PUMPS WITH HEAT	4	▶	DON'T ADD 4 HS PUMPS W/HTR
ADD 2 HS PUMPS WITH HEAT	3	▶	DON'T ADD 2 HS PUMPS W/HTR
ADD 1 HS PUMP WITH HEAT	2	▶	DON'T ADD 1 HS PUMP W/HTR
TEST MODE ON	1	▶	TEST MODE OFF

*SWITCH # 6 SHOULD BE SET TO OFF UPON FINAL INSTALLATION. ALL UNUSED SWITCHES SHOULD BE OFF



FOR SUPPLY CONNECTIONS, USE CONDUCTORS SIZED ON THE BASIS OF 60°C AMPACITY BUT RATED MINIMUM OF 90°C. USE COPPER CONDUCTORS ONLY EMPLOYER UNIQUEMENT DES CONDUCTEURS DE CUIVRE.

TORQUE RANGE FOR MAIN TERMINAL BLOCK (TB1): 27-30 I.N. LBS. (31.1-34.5 kg cm)

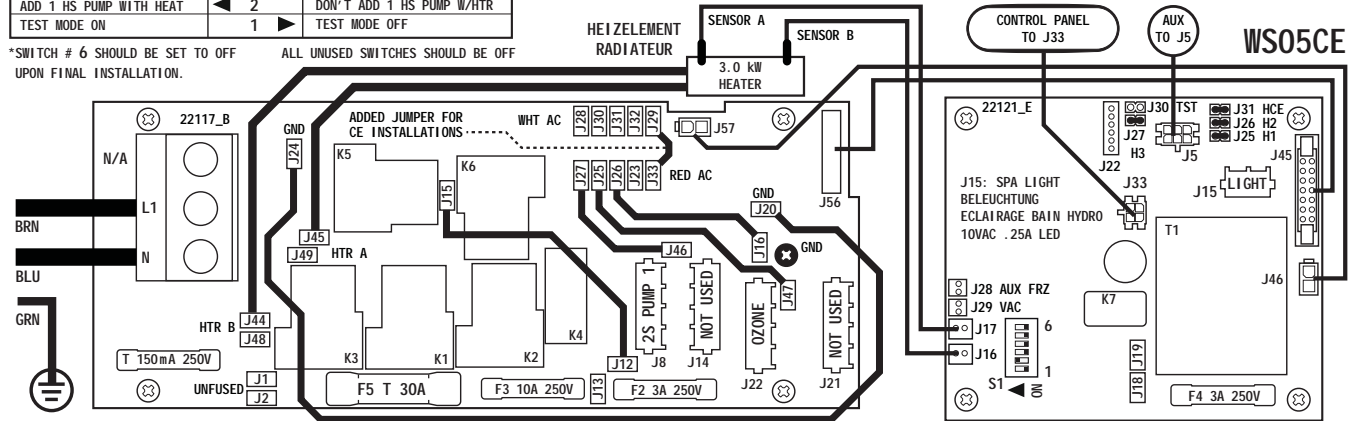

Software Configuration Changes based on Default Feature

Feature	Orig. Setup 1	Changes to
J14, TP600 Button 2, TP400 Button 4, LED 2, AX10A2	Pump 2	<i>Not Used</i>
DIP Switch Option		
Add 1 High Speed Pump with Heat	DIP Switch 2 OFF	<i>DIP Switch 2 ON</i>
J2 & J32	Hot Output	<i>Useable</i>

Refer to Page 3 to choose a suitable Plumbing Kit.

Blue indicates changes from the original Setup 1 default



Manufactured under one or more of these patents. U.S. Patents: 5332944, 5361215, 5550753, 5559720, 5,883,459, 6253227, 6282370, 6590188, 6976052, 6965815, 7030343, 7,417,834 b2, Canadian Patent: 2342614, Australian patent: 2373248 other patents both foreign and domestic applied for and pending. All material copyright of Balboa Water Group.

Setup 6-16

Power Requirements:

Single Service [3 wires (line, neutral, ground)]
 230VAC, 50Hz, 1p, 16A, (Circuit Breaker rating = 20A max.)

System Outputs:

Pump 1	230VAC	1-Speed	12A max	15-minute timer
Circ Pump	230VAC	1-Speed	2A max	Programmable Filtration Cycles + Polling
This is the heater pump Must deliver a minimum of 20 GPM through heater				
Ozone	230VAC		.5A max	Uses the same relay as the Circ Pump
Spa Light	10VAC	On/Off	1A max	4-Hour timer.
Heater	3kW @ 240VAC			

Wiring Diagram and Settings

ON POSITION	S1 SWITCH #	OFF POSITION
MEMORY RESET*	6	STORE SETTINGS*
SPECIAL AMPERAGE RULE ON	5	SPECIAL AMPERAGE RULE OFF
ADD 4 HS PUMPS WITH HEAT	4	DON'T ADD 4 HS PUMPS W/HTR
ADD 2 HS PUMPS WITH HEAT	3	DON'T ADD 2 HS PUMPS W/HTR
ADD 1 HS PUMP WITH HEAT	2	DON'T ADD 1 HS PUMP W/HTR
TEST MODE ON	1	TEST MODE OFF

*SWITCH # 6 SHOULD BE SET TO OFF UPON FINAL INSTALLATION. ALL UNUSED SWITCHES SHOULD BE OFF



FOR SUPPLY CONNECTIONS, USE COPPER CONDUCTORS ONLY. USE CONDUCTORS SIZED ON THE BASIS OF 60°C AMPACITY BUT RATED MINIMUM OF 90°C. EMPLOYER UNIQUEMENT DES CONDUCTEURS DE CUIVRE.

TORQUE RANGE FOR MAIN TERMINAL BLOCK (TB1): 27-30 IN. LBS. (31.1-34.5 kg cm)

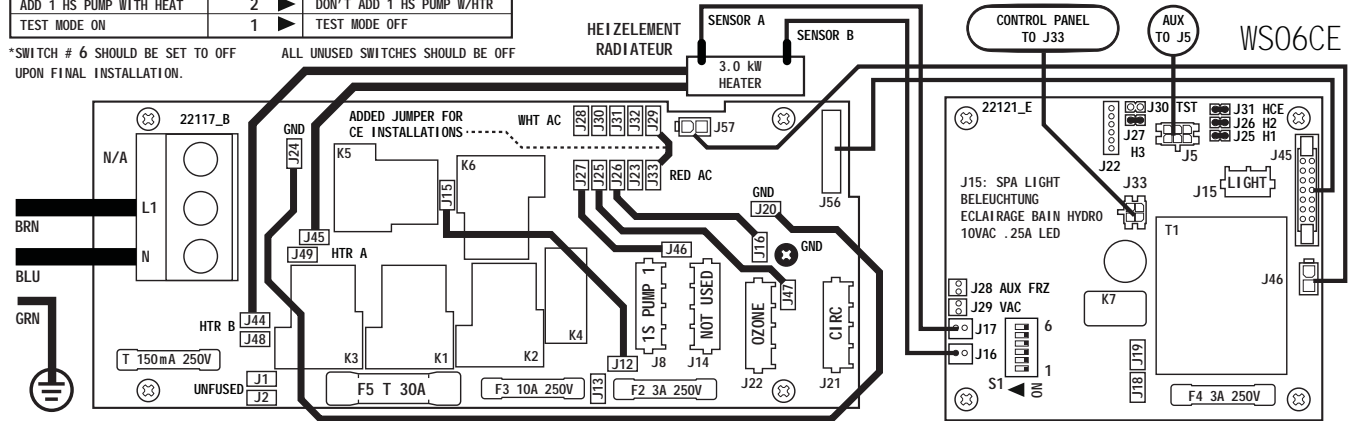

Software Configuration Changes based on Default Feature

Feature	Orig. Setup 1	Changes to
J8	2-Speed Pump 1	1-Speed Pump 1
J14, TP600 Button 2, TP400 Button 4, LED 2, AX10A2	Pump 2	Not Used
J21	Not Used (non-circ)	Circ Pump Enabled

Refer to Page 3 to choose a suitable Plumbing Kit.

Blue indicates changes from the original Setup 1 default



Manufactured under one or more of these patents. U.S. Patents: 5332944, 5361215, 5550753, 5559720, 5,883,459, 6253227, 6282370, 6590188, 6976052, 6965815, 7030343, 7,417,834 b2, Canadian Patent: 2342614, Australian patent: 2373248 other patents both foreign and domestic applied for and pending. All material copyright of Balboa Water Group.

Setup 6-32

Power Requirements:

Single Service [3 wires (line, neutral, ground)]
 230VAC, 50Hz, 1p, 32A, (Circuit Breaker rating = 40A max.)

System Outputs:

Pump 1	230VAC	1-Speed	12A max	15-minute timer
Circ Pump	230VAC	1-Speed	2A max	Programmable Filtration Cycles + Polling
		This is the heater pump Must deliver a minimum of 20 GPM through heater		
Ozone	230VAC		.5A max	Uses the same relay as the Circ Pump
Spa Light	10VAC	On/Off	1A max	4-Hour timer.
Heater	3kW @ 240VAC			
Misc.	J2 & J32	230VAC	3A max	Hot output (Stereo). Fused equipment or in-line fuse required.

Wiring Diagram and Settings

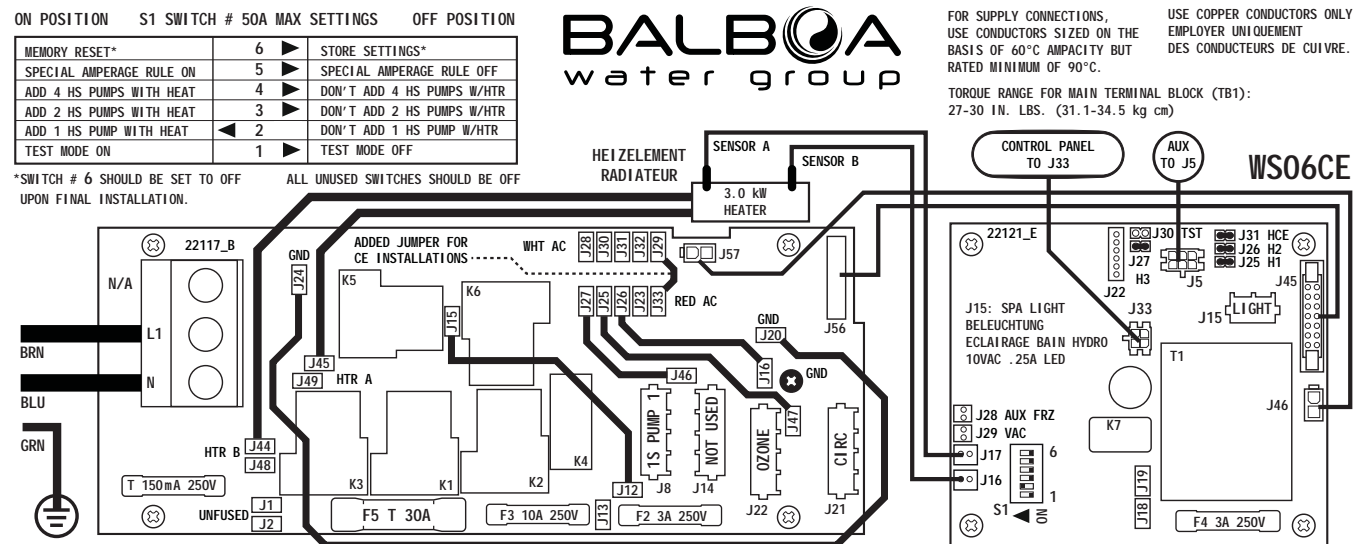

Software Configuration Changes based on Default

Feature	Orig. Setup 1	Changes to
J8	2-Speed Pump 1	<i>1-Speed Pump 1</i>
J14, TP600 Button 2, TP400 Button 4, LED 2, AX10A2	Pump 2	<i>Not Used</i>
J21	Not Used (non-circ)	<i>Circ Pump Enabled</i>
J2 & J32	Hot Output	<i>Useable</i>
Add 1 High Speed Pump with Heat	DIP Switch 2 OFF	<i>DIP Switch 2 ON</i>

DIP Switch Option



Refer to Page 3 to choose a suitable Plumbing Kit.

Blue indicates changes from the original Setup 1 default

Manufactured under one or more of these patents. U.S. Patents: 5332944, 5361215, 5550753, 5559720, 5,883,459, 6253227, 6282370, 6590188, 6976052, 6965815, 7030343, 7,417,834 B2, Canadian Patent: 2342614, Australian patent: 2373248 other patents both foreign and domestic applied for and pending. All material copyright of Balboa Water Group.

Setup Changes with DIP Switch 1 ON

Read and understand these instructions before beginning this process.

Know the Setup Number you want before you power up the spa and wait to power up the spa until you're ready to change the Setup Number.

The system must be in Test Mode, so move Switch 1 to the ON position. The Test Menu will then be available.

Power up the spa, and press any button once to Link the panel. (Note: Switch 1 can be moved to the ON position immediately after power-up, if preferred - Danger! High Voltage will be present!)

You will have 1 minute to complete the setup change after you manually exit Priming Mode. (Once familiar with the process, the Setup change should take less than 15 seconds.)

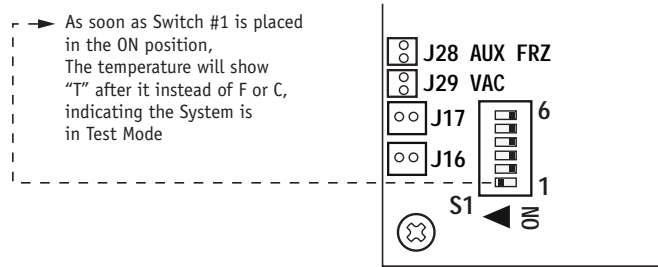

DANGER! HIGH VOLTAGE WILL BE ACCESSIBLE! SERVICE TECHNICIAN ONLY!

Move DIP Switch 1 (on S1 on the Logic circuit board) to ON.

The system will enter Test Mode.

Moving DIP Switch 1 to OFF will exit Test Mode.



When the panel displays RUN PMPS PURG AIR, press any Temperature button ONCE to exit Priming Mode. You should see "---T" where the T indicates the system is in Test Mode.

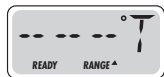

Continued on Next Page.



Setup Changes – Continued

Again, **You will have 1 minute** to complete the setup change after you manually exit Priming Mode.

Immediately after exiting Priming Mode, press this sequence of buttons: Warm*, Light, Warm, Warm, Warm, Warm. Continue to press Warm until the display shows the Setup Number (S-01, S-02, etc.) you want to switch to. When the correct setup number is showing, press Light once, and the system will reset, using the newly-selected Setup from that point on.

Move DIP Switch 1 to the OFF position to take the spa out of Test Mode. °F or °C will replace °T.

Using a permanent marker, write the Setup number on the Setup label mounted inside the system lid (right). This is very important to any service person in the future who may need to replace a circuit board or system and needs to change the Setup on a replacement part while in the field.

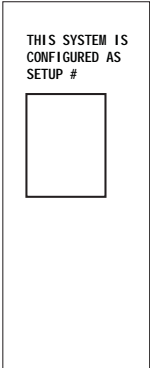

NOTE: Changing the Setup may require wiring changes as well - refer to the wiring diagram or wiring diagram addendum.

Key

- █ Indicates Flashing or Changing Segment
- █ Indicates Alternating or Progressive Message - every 1/2 second
- ⏏ A temperature button, used for "Action"
- ☀ Light or dedicated "Choose" button, depending on control panel configuration
- Waiting time - varies depending on function

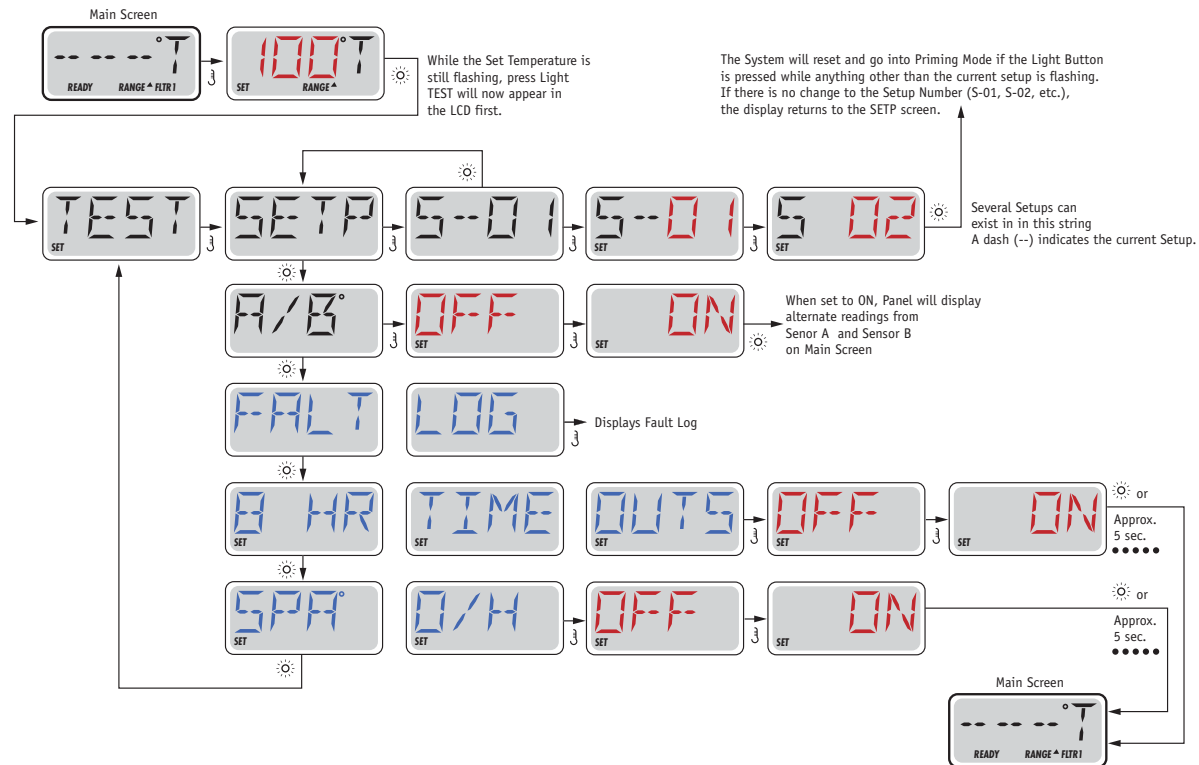

*If the Control Panel does not have a Warm (Up) button, but rather a single Temp button, use the Temp button in place of the Warm button in the instruction above. (The flow chart assumes a single Temperature Button.)



IT Electrical System (No Neutral)

The wiring diagram in the system show connections for TN and TT electrical services (Line, Neutral, Ground).

IT Power Requirements:

Single Service [3 wires (line, line, ground)]
230VAC, 50Hz, 1p, 16A/32A, (Circuit Breaker rating = 20A/40A max.)

Protective Earth Wire (Green/Yellow) must be connected to system ground terminal as marked.

All equipment (pumps, blower, and heater) runs on service line L1 with L2 acting as the return - 230VAC.

Set the DIP switches according to the wiring diagram so that total system current draw never exceeds the rated service input when using a particular setup.

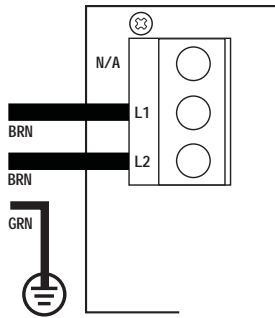

Three Service [4 wires (line, line, line, ground)]
230VAC, 50Hz, 1p, 16A/32A, (Circuit Breaker rating = 20A/40A max.)

Protective Earth Wire (Green/Yellow) must be connected to system ground terminal as marked.

All equipment (pumps, blower, and heater) runs on service line L1 with L2 acting as the return - 230VAC.

Set the DIP switches according to the wiring diagram so that total system current draw never exceeds the rated service input when using a particular setup.

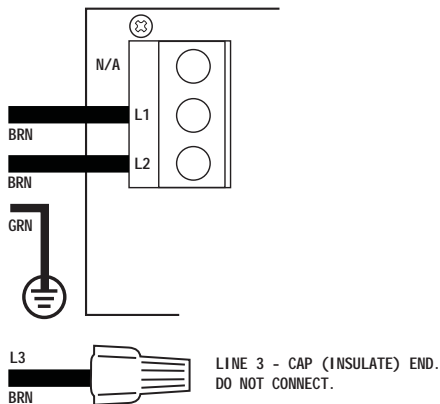

Refer to Page 3 to choose a suitable Plumbing Kit.

Blue indicates changes from the original Setup 1 default

Manufactured under one or more of these patents. U.S. Patents: 5332944, 5361215, 5550753, 5559720, 5,883,459, 6253227, 6282370, 6590188, 6976052, 6965815, 7030343, 7,417,834 b2, Canadian Patent: 2342614, Australian patent: 2373248 other patents both foreign and domestic applied for and pending. All material copyright of Balboa Water Group.

Configuration Options

General Features

Feature	Default
Pump 1 in Filter Cycle (Circ Only)	No
Pump 1 Low Timer	30 Minutes
General Pump Timer	15 Minutes
Blower Timer	15 Minutes
Mister Timer (N/A)	15 Minutes
Light Timer	240 Minutes
Circ	Like P1 Low
Cleanup Cycle	<i>30 Minutes</i>
Cleaup as Preference setting	<i>Yes</i>
Ozone	With Heater Pump*
Ozone Suppression	OFF
Pump Purge	60 Seconds
Blower Purge	30 Seconds
Mister Purge (N/A)	5 Seconds

* The Heater Pump can be either a Circ Pump or Pump 1 Low.



Blue Indicates New Custom Configuration Default (Setup 1)

Manufactured under one or more of these patents. U.S. Patents: 5332944, 5361215, 5550753, 5559720, 5,883,459, 6253227, 6282370, 6590188, 6976052, 6965815, 7030343, 7,417,834 b2, Canadian Patent: 2342614, Australian patent: 2373248 other patents both foreign and domestic applied for and pending. All material copyright of Balboa Water Group.

Configuration Options

Temperature Features

Feature Default

Temperature Display

°C

All temperatures must be specified in °F. The system converts °F to °C dynamically. If Celsius is required for default settings, choose a desired °C value that (after rounding) corresponds to a Fahrenheit value.

°C	4	5	6	7	8	9	10	11	12	13	14	15	16	17	18	19	20	21	22
°F	39	41	43	45	46	48	50	52	54	55	57	59	61	63	64	66	68	70	72
°C	23	24	25	26	27	28	29	30	31	32	33	34	35	36	37	38	39	40	
°F	73	75	77	79	81	82	84	86	88	90	91	93	95	97	99	100	102	104	

Hi-Range Min. Set Temp	80°F
Hi-Range Max. Set Temp	104°F
Hi-Range Default Temp*	100°F
Lo-Range Min. Set Temp	50°F
Lo-Range Max. Set Temp	99°F
Lo-Range Default Temp*	70°F
Freeze Threshold	44°F
Temp Lock Type	Temp + Settings

Time Features

Feature Default

Time Format*

24 Hour

Filter 1 Start Hour*

8:00 PM (20:00)

Filter 1 Duration*

2 Hours

Filter Cycle 2 Default*

OFF

Filter 2 Start Hour*

8:00 AM (08:00)

Filter 2 Duration*

15 Minutes

Light Cycle

Disabled

Light Cycle Default*

OFF

Light Cycle Start Hour*

9:00 PM (21:00)

Light Cycle Duration*

15 Minutes

*May be changed by end-user (if Enabled)



Blue Indicates New Custom Configuration Default (Setup 1)

Manufactured under one or more of these patents. U.S. Patents: 5332944, 5361215, 5550753, 5559720, 5,883,459, 6253227, 6282370, 6590188, 6976052, 6965815, 7030343, 7,417,834 b2, Canadian Patent: 2342614, Australian patent: 2373248 other patents both foreign and domestic applied for and pending. All material copyright of Balboa Water Group.

Configuration Options

Reminder Features

Feature	Default
Reminders Shown*	<i>Yes</i>
Check pH	<i>OFF</i>
Check Sanitizer	<i>OFF</i>
Clean Filter	30 Days
Test GFCI	<i>65 Days</i>
Drain Water	<i>100 Days</i>
Change Cartridge	OFF
Clean Cover	<i>OFF</i>
Treat Wood	<i>OFF</i>
Change Filter	365 Days

Special Features

Feature	Default
Special Amperage Rule A (DIP SW 5 OFF)	No Limitation
Special Amperage Rule B (DIP SW 5 ON)	1 High-Speed Pump**
Drain Mode	Disabled
Demo Mode	Disabled
Automatic GFCI Test	Disabled
Ozone Slaved to Heater Pump	<i>Yes</i>

* *Editable by end-user*

** Special Amperage Rule B is (DIP Switch 5 ON) is only used with Setup 1-16 (Page 4).
This setting will not allow both Pump 1 High and Pump 2 to run at the same time.



Blue Indicates New Custom Configuration Default (Setup 1)

Manufactured under one or more of these patents. U.S. Patents: 5332944, 5361215, 5550753, 5559720, 5,883,459, 6253227, 6282370, 6590188, 6976052, 6965815, 7030343, 7,417,834 b2, Canadian Patent: 2342614, Australian patent: 2373248 other patents both foreign and domestic applied for and pending. All material copyright of Balboa Water Group.

Configuration Options

TP400 Control Panel Features

Feature	TP400T	TP400W
Button 1	Temperature	Up
Button 2	Jets 1	Down
Button 3	Light 1	Light 1
Button 4	Jets 2	Jets 1
LED B1	Heat ON	Heat ON
LED B2	Jets 1	Unused
LED B3	Light 1	Light 1
LED B4	Jets 2	Jets 1

TP400T

50260 ►

Includes Overlay PN 12511

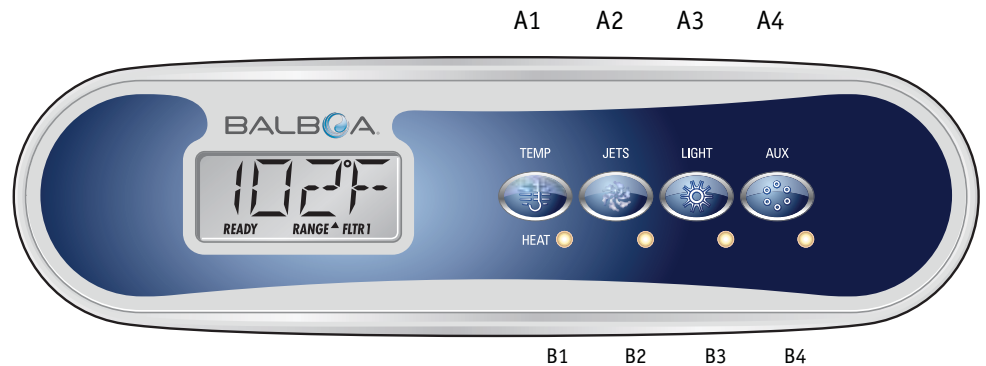

TP400W

50260 ►

Includes Overlay PN 12510

TP400W requires the use of an AX10A2 in Setups 1 – 4.

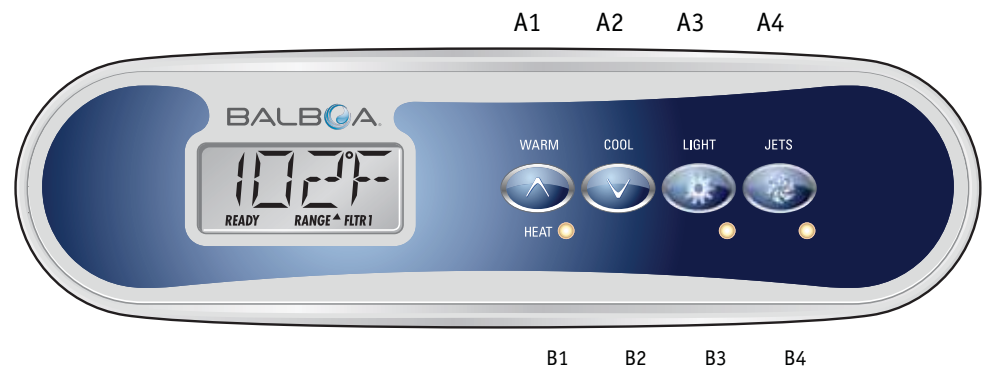

Download the User Interface and Programming Guide here:

http://service.balboa-instruments.com/zz40940_download.zip

Blue Indicates New Custom Configuration Default (Setup 1)

Manufactured under one or more of these patents. U.S. Patents: 5332944, 5361215, 5550753, 5559720, 5,883,459, 6253227, 6282370, 6590188, 6976052, 6965815, 7030343, 7,417,834 b2, Canadian Patent: 2342614, Australian patent: 2373248 other patents both foreign and domestic applied for and pending. All material copyright of Balboa Water Group.

Template 40941_J 04-02-10

Configuration Options

TP600 Control Panel Features

Feature	Default
Button 1	<i>Jets 1</i>
Button 2	<i>Jets 2</i>
Button 3	<i>Flip</i>
Button 4	<i>Up</i>
Button 5	<i>Light 1</i>
Button 6	<i>Down</i>
LED 1	<i>Jets 1</i>
LED 2	<i>Jets 2</i>
LED 3	<i>Light 1</i>
LED 4	<i>Heat ON</i>

TP600CE

50014-01 ►

Includes Overlay PN 12101

TP600 (non-CE) should not be used



Download the User Interface and Programming Guide here:

http://service.balboa-instruments.com/zz40940_download.zip

Blue Indicates New Custom Configuration Default (Setup 1)

Manufactured under one or more of these patents. U.S. Patents: 5332944, 5361215, 5550753, 5559720, 5,883,459, 6253227, 6282370, 6590188, 6976052, 6965815, 7030343, 7,417,834 b2, Canadian Patent: 2342614, Australian patent: 2373248 other patents both foreign and domestic applied for and pending. All material copyright of Balboa Water Group.

Template 40941_J 04-02-10

Configuration Options

Auxilliary Panel Features

Feature	Default
Aux Button A1	Jets 1
Aux Button A2	Jets 2
Aux Button A3	<i>Unused</i>
Aux Button A4	Light

AX10 A1	No O/L	52803	
AX10 A2	AUX O/L	55919	▶
AX10 A3	No O/L	52805	
AX10 A4	No O/L	52806	



AX20 A1A2	No O/L	52800
AX20 A1A3	No O/L	52801
AX20 A1A4	No O/L	52802

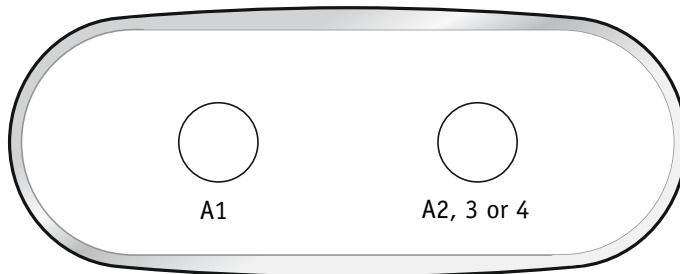

AX40	No O/L	52799
------	--------	-------

