

# GL2000 Mach 3 Tech Sheet

## Balboa Instruments System PN 55048-04

System Model # GL2-GL2000M3-RCA-3.0

Software Version # 32

EPN # 2833

Base PCBA – PN 53708-04

PCB GL2000 – PN 22898 Rev B, C, or D

HEX File – 10011932

### Base Panels

ML900 – PN 52654-01

ML700 – PN 52649-01

ML400 – PN 52684



# System Revision History

System PN	EPN	Date	Requested By	Changes Made
55048-02	2130	12.06.2006	Balboa	Software update to v28
55048-03	n/a	07.23.2007	Balboa	Software update to v30
55048-04	2833	05.06.2008	Balboa	Software update to v32

# Basic System Features and Functions

## Power Requirements

Single Service [3 wires (line, neutral, ground)]

- 230VAC, 50Hz, 1~, 16A/32A, (Circuit Breaker rating = 20A/40A max.)

Dual Service [5 wires (line 1, neutral 1, line 2, neutral 2, ground)]

- 230VAC, 50Hz, 1~, 2x 16A, (Circuit Breaker rating = 20A max each service.)

3-Phase Service [5 wires (line 1, line 2, line 3, neutral, ground)]

- 400VAC, 50Hz, 3N~, 16A, (Circuit Breaker rating = 20A max each phase line.)
- **IMPORTANT** - Service must include a neutral wire, with a line to neutral voltage of 230VAC.

## Setup 1 (As Manufactured)

- 230V Pump 1, 2-Speed
- 230V Pump 2, 1-Speed
- 230V Blower, 1-Speed
- 230V Ozone
- 10V Spa Light
- 230V AV (Stereo)
- 3.0kW 800 Incoloy Heater \*

## Optional Devices

- 230V Circ Pump

\* Heater wattage is rated at 240V.

## Additional Options

- Full Feature Dolphin Remote and Spa-only Dolphin Remote  
Connects to Main Panel terminal J70 or J71 or J72
- IR or RF Dolphin Receiver Module  
Connects to Remote terminal J20
- Ozone Generator  
Connects to terminal J9
- MoodEFX Lighting  
Connects to Spa Light terminal J12
- FiberEFX Lighting  
Connects to Spa Light terminal J12
- Stereo System  
Connects to A.V. terminal J4

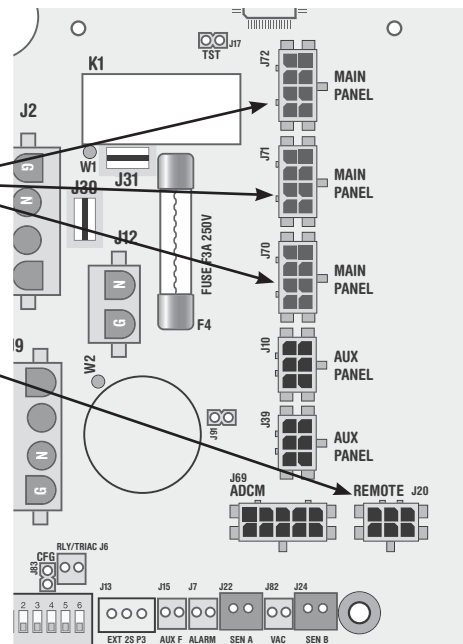

# Persistent Memory and Powering Up

Any time you change DIP Switches or Software Configuration Settings that affect parameters the user can change (any filter settings, set temperature default, Celsius vs Fahrenheit, 12-hour vs 24-hour time, reminders suppression, etc), you must reset Persistent Memory for your DIP Switch or Software Configuration Settings changes to take effect. You should also reset Persistent Memory after loading a new file into a board (using the ESM, purchased separately).

## To reset Persistent Memory:

- Power down.
- Set A12 ON (See illustration below).
- Power up.
- Wait until “P” or “PRIMING MODE” is displayed on your panel.  
Note: If “CFE” appears see section below.
- Set A12 OFF. (This can be done safely with power on if you use a non-conductive tool such as a pencil to push the switch back to the OFF position. Otherwise, power down before setting A12 OFF)
- Power up again (if you powered down in the previous step).
- For all other power ups, leave A12 OFF.

## About Persistent Memory and Time of Day Retention:

This system uses memory that doesn’t require a battery to store a variety of settings. What we refer to as Persistent Memory stores all the User Preferences, as well as all the filter settings, the set temperature, and the heat mode.

Persistent Memory is not used for Time of Day. Time of Day needs to be “kept running” (not just stored) while the power is off, so a separate Real Time Clock feature (on all models except the EL1000) keeps track of Time of Day while the unit is off. Time of Day Retention, and Time of Day Retention alone, is controlled by the J91 jumper. J91 must be set according to main system panel used.

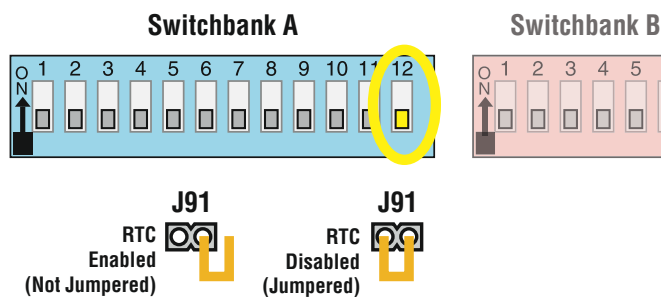

## CFE message on power up:

If “CFE” appears before (and instead of) “P” or “PRIMING MODE”, you have not configured DIP Switches and/or Software Configuration Settings in a valid manner. This must be corrected before you can reset Persistent Memory.

The switch numbers, jumpers, or configuration settings displayed after “CFE” are ones with which the system has found a configuration problem. For example:

- “CFE A5 B2” would mean that the combination of how you’ve set A5 and how you’ve set B2 is not supported on this system.
- “CFE J99” would mean that there is a problem with jumper J99
- “CFE P3 1 BL. 1” would mean that the combination of how you’ve set pump 3 for 1-speed and blower for 1-speed is not supported on this system.
- “CFE P3 BL.” would mean that the combination of how you’ve set DIP switches which have been assigned to pump 3 and blower is not supported on this system.

## Power Up Display Sequence

Upon power up, you should see the following on the display:

- Three numbers in a row, which are the SSID (the System Software ID). The third display of these numbers is the Software Version, which should match the version of your system. For example, if these three numbers are 100 134 26, that is a Mach 3 EL8000 at version 26.
- If there is a Configuration Error, the CFE message (see above) will appear at this point (and none of the messages below will display). Otherwise what comes next is:
- An indication of either the input voltage detected (EL1000/EL2000), or the heater wattage range supported (EL8000/GL2000/GL8000).
  - Heater wattage display: “1-3” means the system supports a heater from 1 kW to 3 kW. “3-6” means the system supports a heater from 3 kW to 6 kW. “3-3” means the system supports a 3 kW heater only. (These ranges may be modified slightly in the case of special heaters, which the next bullet covers.)
  - Input voltage display: A system showing “240” supports 3 kW to 6 kW heaters. A system showing “120” supports the very same heaters, although at 120V those heaters will function at only 1/4 of their 240V rated wattage. (The system shows only either “240” or “120” as a general indication of input voltage; it does not show the actual input voltage.)
- If your system is using a special type of heater, a display such as “H 6” may appear next. If your system is using the generic Balboa heater, no heater type display will appear.
- “P” or “PRIMING MODE” will appear to signal the start of Priming Mode.

At this point, the power up sequence is complete. Refer to the User Guide for the ML Series panel on your system for information about how the spa operates from this point on.

# Wiring Configuration and DIP Settings

## Setup 1 (As Manufactured)

- 230V Pump 1, 2-Speed
- 230V Pump 2, 1-Speed
- 230V Blower, 1-Speed
- 10V Spa Light
- 230V Ozone
- 230V A/V (Stereo)
- 3.0kW 800 Incoloy Heater
- ML900 or ML700 Main Panel
- 230V Circ Pump (opt)

### HiPot Testing Note:

Disconnect slip terminal with green wires from J90 prior to performing HiPot test. Failure to disconnect will cause a false failure of the test.

Reconnect terminal to J90 after successful completion of HiPot test.

Use X-P CE or X-P231 CE  
Expander for Pump 3 1-Speed

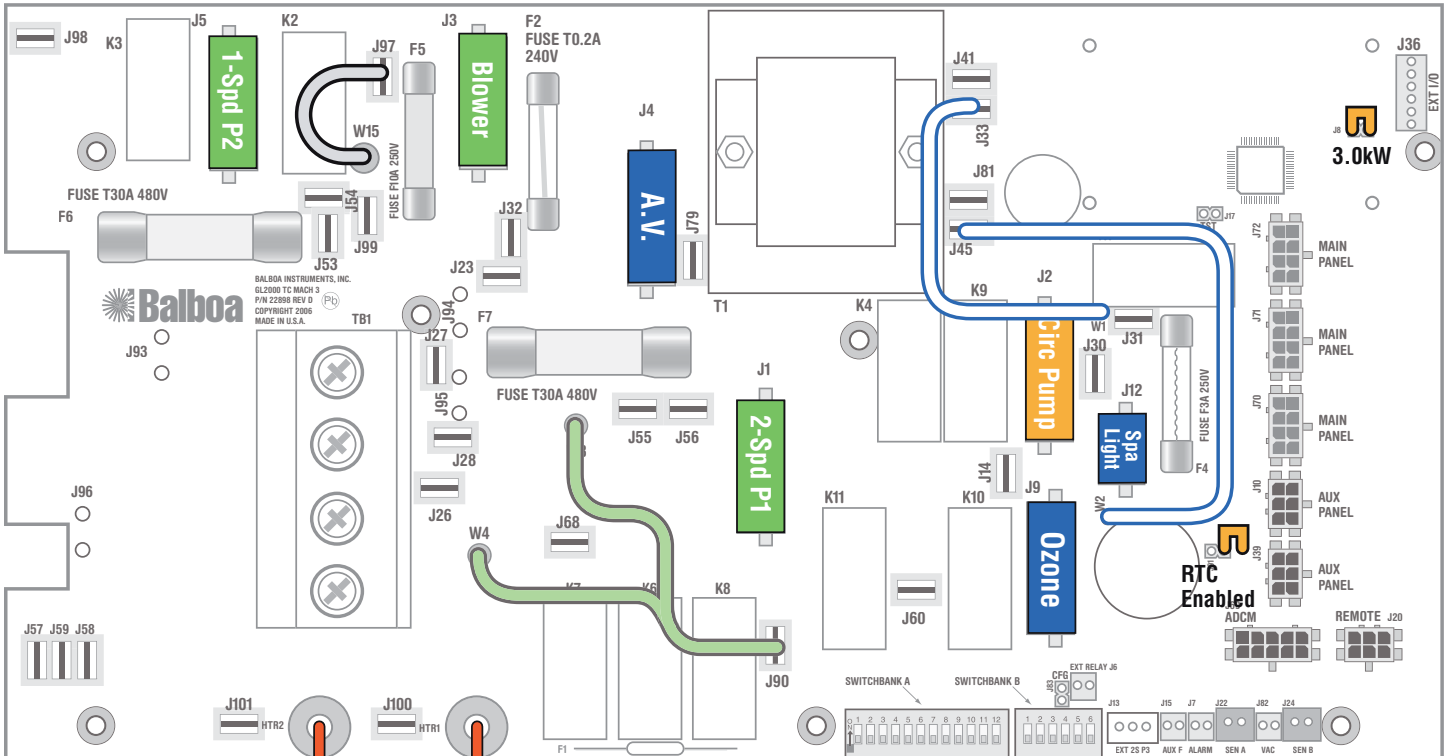

**3.0 kW** Heater rated @ 240V  
J8 must be Jumpered

**WARNING:** Main Power to system should be turned OFF BEFORE adjusting DIP switches.  
**WARNING:** Persistent Memory (A12) must be RESET to allow new DIP switch settings to take effect. (See Persistent Memory page)

When the Logic Jumper is not installed on J83 (CFG),  
DIP Switch Settings are enabled.  
DIP Switches will then operate as shown below.

RTC Enabled (Not Jumpered) J91

CFG

SSID #

100
119
32

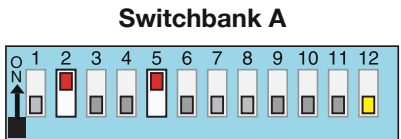

- A1, Test Mode OFF
- A2, High Amp
- A3, Filter by Time
- A4, 12 Hr Time
- A5, Degrees C
- A6, Short Timeouts
- A7, Cleanup Cycle OFF
- A8, 1Hr O<sub>3</sub> Supress OFF
- A9/A10, No Circ Pump
- A11, O<sub>3</sub> w/ P1 Low and P1 is 2-Spd
- A12, Memory Retained**

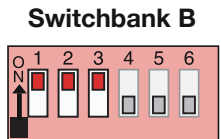

- B1, Pump 2 1-Speed
- B2, Pump 2 Enabled
- B3, Blower Enabled
- B4, No Fiber/Wheel
- B5, Pump 3 Disabled
- B6, Panel Scrunching OFF



**Wiring Color Key**

- Neutral (Common) AC Connections
- Special AC Connections
- Line AC Connections
- 10 Volt Connections
- Relay Control Wires

**Board Connector Key**

- 1 Typically Line voltage
- 2 Typically Line voltage for 2-speed pumps
- 3 Neutral (Common)
- 4 Ground

Note flat sides in connector

# DIP Switches and Jumpers Definitions

**WARNING:**

- Setting DIP switches incorrectly may cause abnormal system behavior and/or damage to system components.
- Refer to Switchbank illustration on Wiring Configuration page for correct settings for this system.
- Contact Balboa if you require additional configuration pages added to this tech sheet.

**DIP Switchbank A Key**

- A1 ..... Test Mode (normally Off)
- A2 ..... In "ON" position, heater can run while any/all high-speed pumps or blowers are running (High amperage)  
 ..... In "OFF" position, heater is disabled while any high-speed pump or blower is running (Low amperage)
- A3 ..... In "ON" position, filter cycles are programmed by duration for non-time capable panels  
 ..... In "OFF" position, filter cycles are programmed to start and end times for time capable panels
- A4\* ..... In "ON" position, displays time in 24 hours (military\European time)  
 ..... In "OFF" position, displays 12 hour time
- A5\* ..... In "ON" position, displays temperature in Celsius  
 ..... In "OFF" position, displays temperature in Fahrenheit
- \* Sets default for user preferences - only applies when persistent memory is reset (A12 On) during power-up
- A6 ..... In "ON" position, Equipment timeout 30 minutes (4 hours for Pump 1-Low)  
 ..... In "OFF" position, Equipment timeout 15 minutes (2 hours for Pump 1-Low)
- A7 ..... In "ON" position, Cleanup Cycle – 30 minutes after spa use/timeout, Pump 1-Low & Ozone or Circ Pump and Ozone run for 1 hour  
 ..... In "OFF" position, no Cleanup Cycle
- A8 ..... In "ON" position, Ozone suppression for one hour after pump/blower button press
- A9 and A10 ..... See **Table** for Circ Pump Behavior settings
- A11 ..... In "ON" position  
 ..... (*non-circ mode operation*) Pump 1 is two-speed, Ozone is ON in Filter & Cleanup Cycles only  
 ..... (*in any circ mode*) Pump 1 is one-speed, Ozone is ON with circ pump  
 ..... In "OFF" position  
 ..... (*non-circ mode operation*) Pump 1 is two-speed, Ozone is ON with Pump 1-Low  
 ..... (*in any circ mode*) Pump 1 is two-speed, Ozone is ON with circ pump
- A12 ..... Persistent memory reset (normally off) (used when spa is powering up)

A9	A10	Circ Pump Behavior
OFF	OFF	No Circ Pump or Circ Pump not plumbed w/heater
ON	OFF	24 Hours
OFF	ON	24 Hr w/3°F Shut-Off
ON	ON	Acts like Pump 1-Low (Filter Cycles, Polls)

**DIP Switchbank B Key**

- B1 ..... In "ON" position, single-speed Pump 2  
 ..... In "OFF" position, two-speed Pump 2
- B2 ..... In "ON" position, Pump 2 enabled  
 ..... In "OFF" position, Pump 2 disabled
- B3 ..... In "ON" position, Blower enabled  
 ..... In "OFF" position, Blower disabled
- B4 ..... In "ON" position, Fiber and Wheel instead of Spa Light  
 (if A9 & A10 are both OFF, Fiber uses J2 connector; if either A9 or A10 is ON, X-FOW Kit required to run Fiber)  
 ..... In "OFF" position, Spa light enabled
- B5 ..... In "ON" position, Pump 3 enabled (Jets 3 replaces Blower on Aux panel)  
 ..... In "OFF" position, Pump 3 disabled
- B6 ..... In "ON" position, Alternate Panel layout (ML900 scrunching enabled - ML550 / 700 Jets 3 replaces Blower)  
 ..... In "OFF" position, Normal Panel layout

**Jumpers**

- J8** Jumper on 1 Pin only when using 2.0kW or 1.0kW heater.  
 Jumper on Pins 1 and 2 when using 3.0kW heater.
- J91** Jumper on 1 Pin only enables Real Time Clock function; use with time capable panels.  
 Jumper on Pins 1 and 2 disables RTC function; use with non-time capable panels.

# Electrical Service Configuration Options

## For DIP Switch Configured System

### Single Service (1 x 16 Amp or 1 x 32 Amp)

This option is configured and shipped as the default.

For 1 x 32 Amp Service:

DIP Switch A2 can be ON

For 1 x 16 Amp Service:

DIP Switch A2 must be OFF

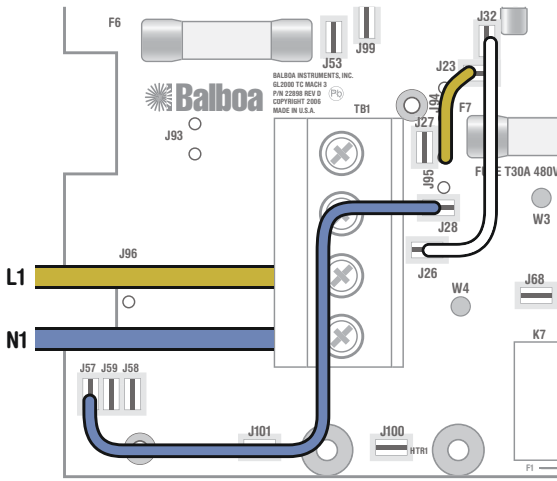

### Dual Service Option (2 x 16 Amp)

Completely remove the white wire from J26 and J32.

*Note: J32 and J23 are electrically identical. The white wire may be attached to either terminal before removal.*

DIP Switch A2 must be ON

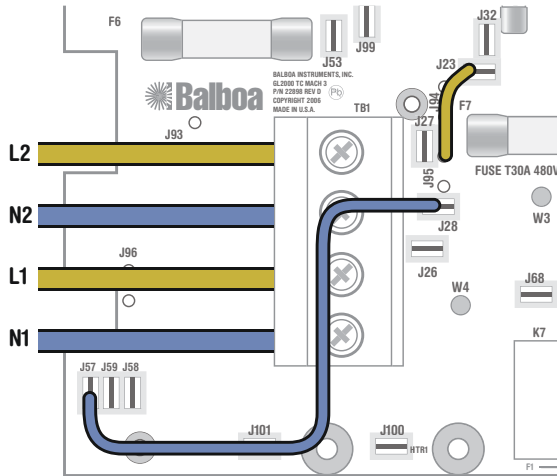

### 3-Phase Service Option

**IMPORTANT** - Service **MUST** include a neutral wire, with a line to neutral voltage of 230VAC.

Completely remove the white wire from J26 and J32.

*Note: J32 and J23 are electrically identical. The white wire may be attached to either of these terminals before removal.*

Completely remove the blue wire from J28 and J57.

*Note: J57, J58 and J59 are electrically identical. The blue wire may be attached to any of these terminals before removal.*

Move the brown wire from J23 or J32 to J28.

DIP Switch A2 must be ON

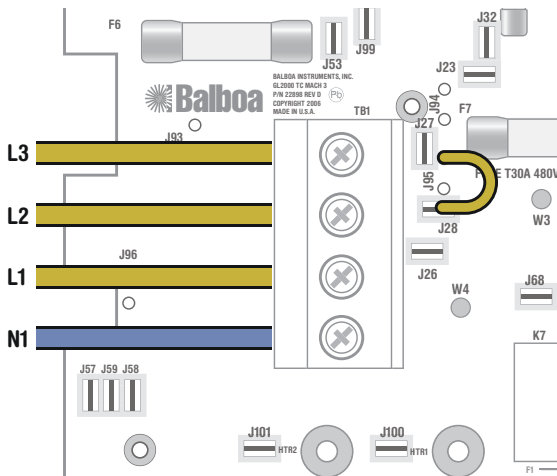



# Ozone Connections

Note: A special tool is required to remove the pins from the connector body once they are snapped in place. Check with your Balboa Account Manager for information on purchasing a pin-removal tool.

## Balboa Ozone connector configuration for 230VAC 50Hz:

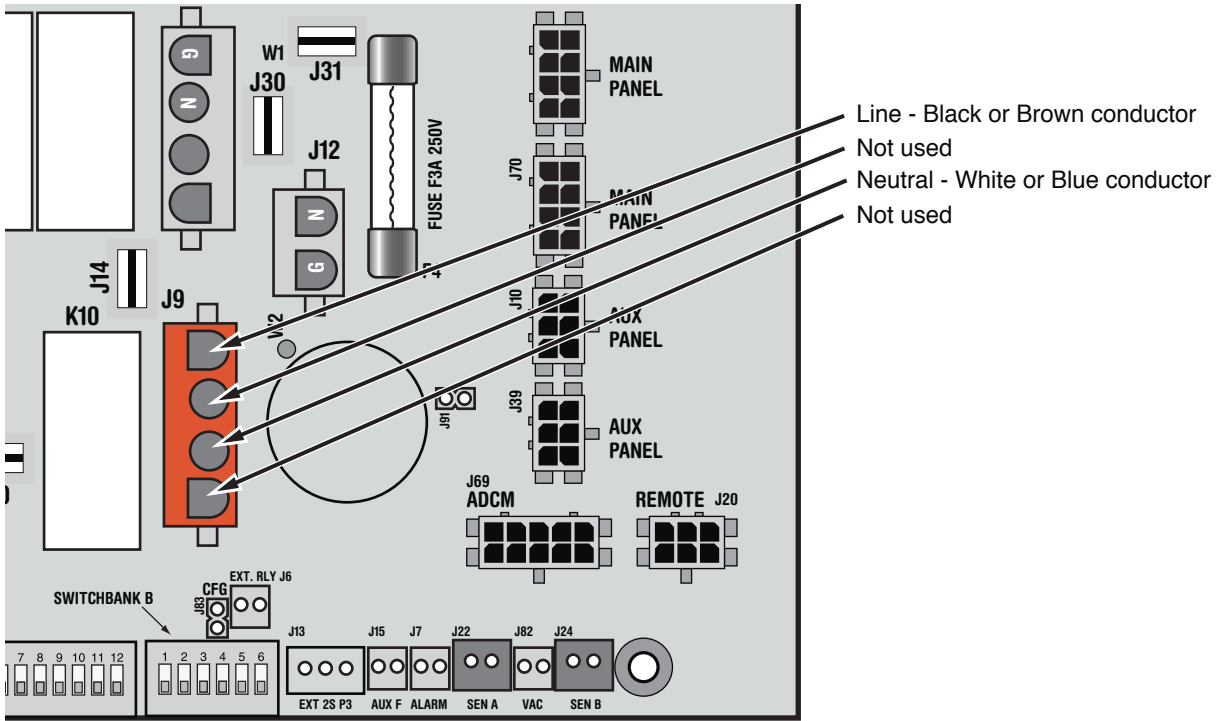
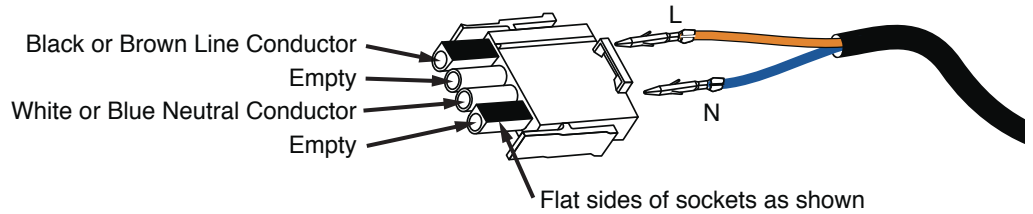



# Panel Configurations

Note: RTC jumper (J91) on Main PCBA must be OFF (1 pin only)



ML900  
 PN 52654-01 with Overlay PN 40026  
 • Connects to Main Panel terminal J70, J71, or J72



ML700  
 PN 52649-01 with Overlay PN 11281  
 • Connects to Main Panel terminal J70, J71, or J72

Note: Connects to Main Panel terminal J70, J71, or J72  
 Note: RTC Jumper (J91) on Main PCBA must be ON (both pins jumpered), unless a Time Capable panel is also used.



ML400  
 PN 52684 with Overlay PN 11345

TIME CAPABLE

NON-TIME CAPABLE