

# GS500Z-2K Hot Sheet

## Balboa Instruments System PN 54523

System Model # GS5-GS500Z-RCA-2.0k

Software Version # 38

EPN # 1776

Base PCBA - PN 54510

PCB GS500Z - PN 22015 Rev A

### Base Panels

Mini – PN 52144

Lite Digital – PN 54094

Lite Duplex – PN 51676







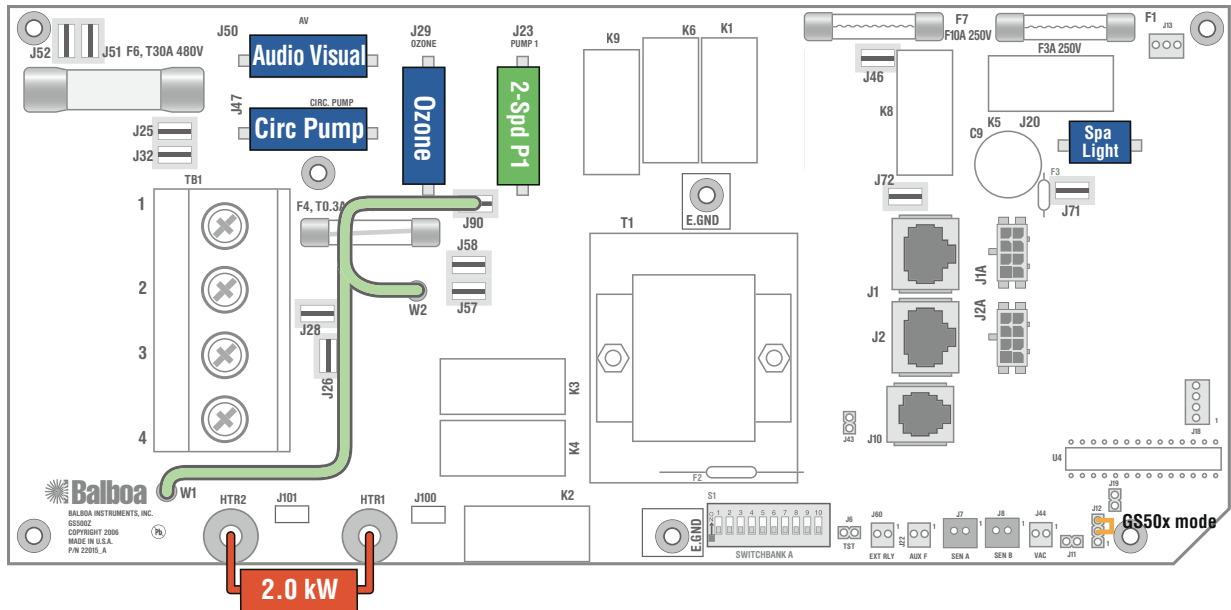





# Wiring Configuration



## Wiring Color Key

-  Neutral (Common) AC Connections
-  Special AC Connections
-  Line AC Connections
-  10 Volt Connections
-  Relay Control Wires

## Connector Key

-  Typically Line voltage
  -  Typically Line voltage for 2-speed pumps
  -  Neutral (Common)
  -  Ground
- Note flat sides in connector

## HiPot Testing Note:

Disconnect slip terminal with green wires from J90 prior to performing HiPot test. Failure to disconnect will cause a false failure of the test.

Reconnect terminal to J90 after successful completion of HiPot test.

PCB Revision	History
A	Production Release

# Electrical Service Configuration Options

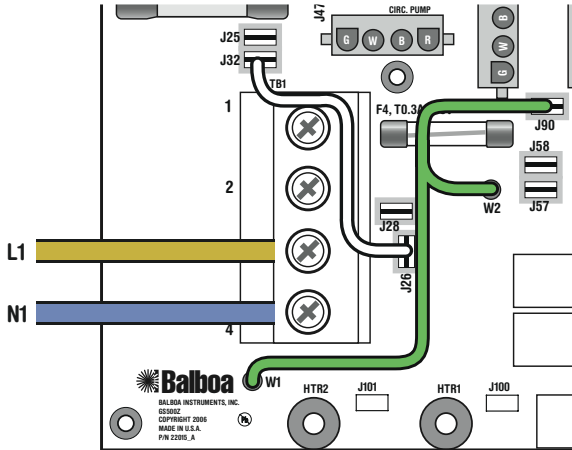

## Single Service (1 x 16 Amp or 1 x 32 Amp)

This option is configured and shipped as the default.

For 1 x 32 Amp Service:

DIP Switch A10 can be ON

For 1 x 16 Amp Service:

DIP Switch A10 must be OFF

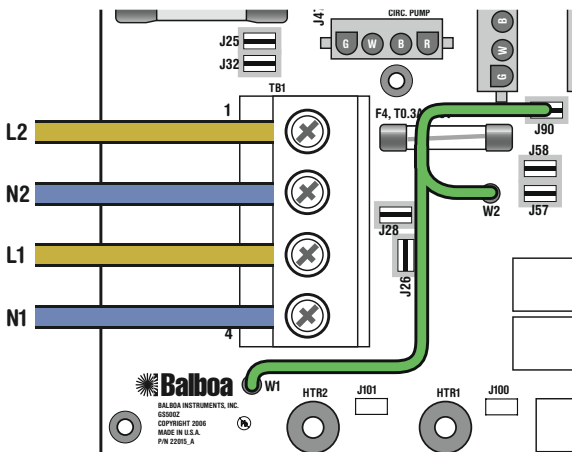

## Dual Service Option (2 x 16 Amp)

Completely remove the white wire from J26 and J32.

*Note: J32 and J25 are electrically identical. The white wire may be attached to either terminal before removal.*

DIP Switch A10 must be ON

# Configuration Options

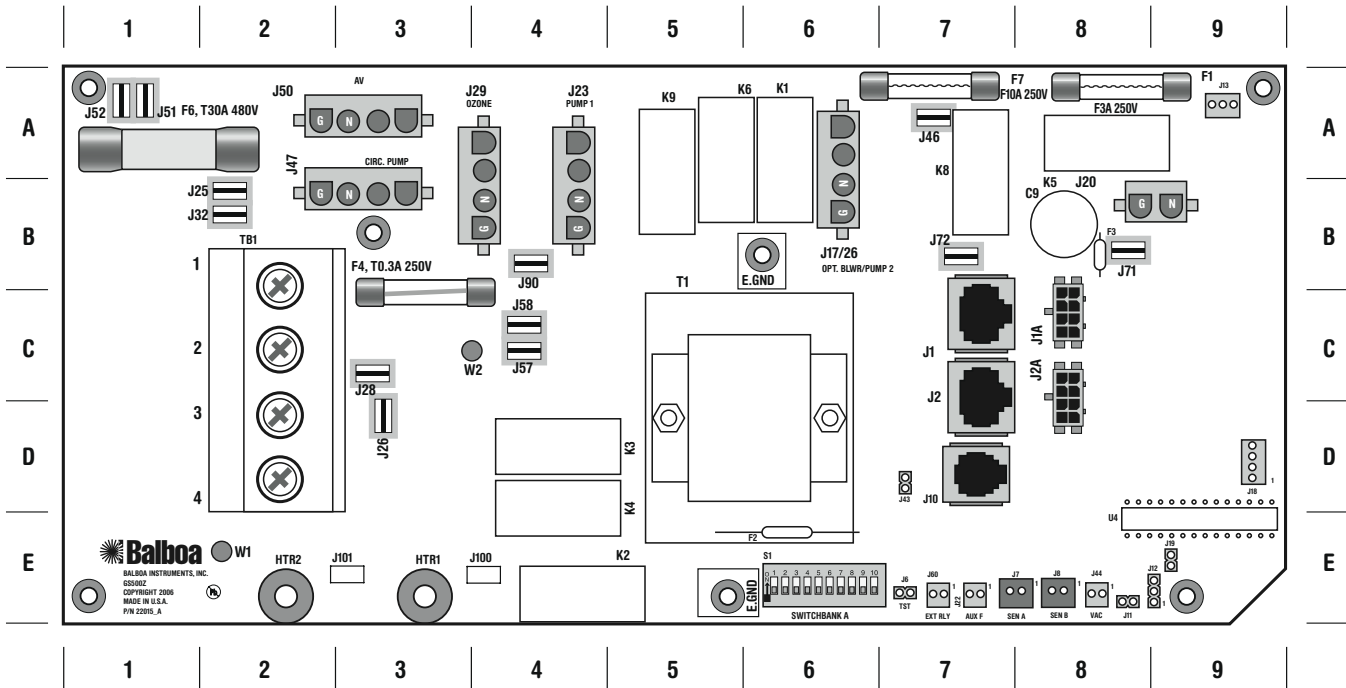

## Output Features

- J50 Audio Visual (always hot - no relay)
- J47 Circ Pump
- J29 Ozone

Note: If a circ pump and ozone need a separate relay  
Use the X-03 CE Expander board

- J23 2-Speed Pump 1
- J20 Spa Light

## Quadrant

- 3-A
- 3-A
- 4-A
- 4-A
- 8-B

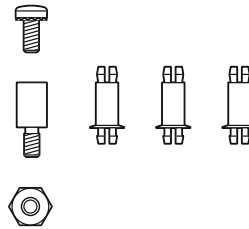

## X-Mount P

PN 53933

Used for mounting any Expander Board in a plastic enclosure.  
Standoffs attach to heater mounting bracket.

System can be factory configured for either a Duplex Topside Panel, a Serial Standard Panel, or a Digital Deluxe Panel.

Note: Some panels styles are not available depending on system configuration. Consult your Balboa product representative for details.

## NOTE Regarding J12 (Quadrant 9-E):

When J12 on the Main Board is jumpered on pins 2 & 3, the system is in GS50xZ compatibility mode.

If J12 on the Main Board is jumpered on pins 1 & 2, the system is in GS51xZ/GS5xxSZ/GS5xxDZ compatibility mode.

# Expander Options

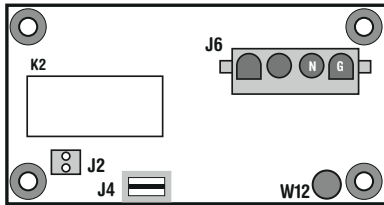

**X-P CE PN 53547**

Used for a 1-speed Pump output.

- J4 on X-P CE connects directly to Line AC using J52 or J51 on the main GS500Z PCBA.
- J2 on X-P CE connects to J60 on the main board.
- W12 on X-P CE connects directly to Neutral AC using J57 or J58 on the main GS500Z PCBA.

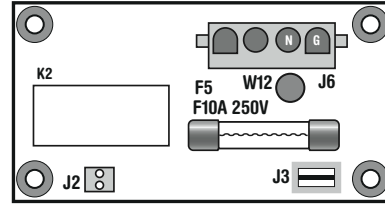

**X-B CE PN 53311**

Used for a Blower output ONLY.

- J3 on X-B CE connects directly to Line AC using J52 or J51 on the main GS500Z PCBA.
- J2 on X-B CE connects to J60 on the main board.
- W12 on X-B CE connects directly to Neutral AC using J57 or J58 on the main GS500Z PCBA.

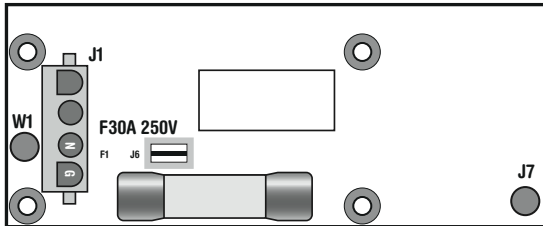

**X-P231 CE PN 55025**

Can replace the X-P CE in cases where branch circuit protection is needed for high amperage devices that would over-burden power input fuse F6 (1-A) on the main PCBA.

- J6 on X-P231 CE connects directly to Line AC using J25 or J32 on the main GS500Z PCBA, depending on AC Service Configuration.
- J7 on X-P231 CE connects to J60 on the main board.
- W1 on X-P231 CE connects directly to Neutral AC using J57 or J58 on the main GS500Z PCBA.

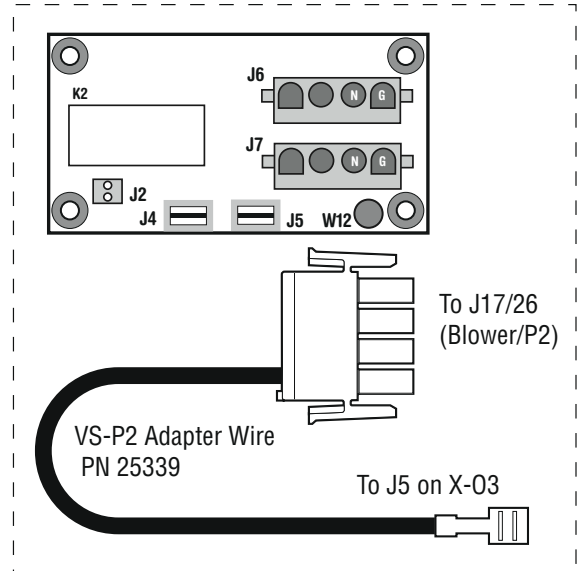

**X-2SP CE Kit PN 53985**

Adapter PN 25339 is used in conjunction with an X-03 CE to run a 2-speed Pump 2.

No Blower is available when this kit is used.

- J4 on X-03 CE connects directly to Line AC using J52 or J51 on the main GS500Z PCBA.
- J2 on X-P CE connects to J60 on the main board.
- W12 on X-P CE connects directly to Neutral AC using J57 or J58 on the main GS500Z PCBA.
- J5 on X-P CE connects J17/26 connector on the main GS500Z PCBA using adapter wire VS-P2.

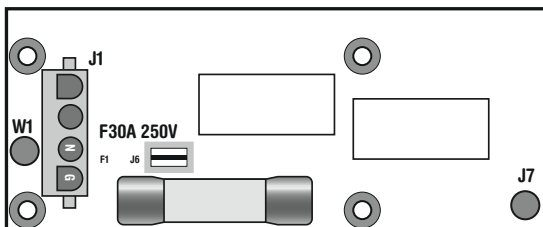

**X-P332 CE PN 55138**

Can replace the X-P CE in cases where branch circuit protection is needed for high amperage devices that would over-burden power input fuse F6 (1-A) on the main PCBA.

- J6 on X-P332 CE connects directly to Line AC using J25 or J32 on the main GS500Z PCBA, depending on AC Service Configuration.
- J7 on X-P332 CE connects to J13 on the main board.
- W1 on X-P332 CE connects directly to Neutral AC using J57 or J58 on the main GS500Z PCBA.

# DIP Switches and Jumpers

**SSID #**  
100  
61  
38

## Switchbank A

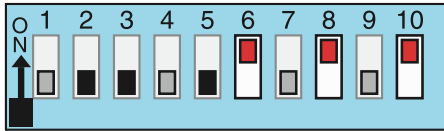

- |                              |                                 |
|------------------------------|---------------------------------|
| <b>A1, Test Mode OFF</b>     | <b>A6, 50 Hz</b>                |
| <b>A2, U, J, T, L</b>        | <b>A7, Mode changes allowed</b> |
| <b>A3, Duplex Panel</b>      | <b>A8, Degrees C</b>            |
| <b>A4, Aux Freeze</b>        | <b>A9, Circ Pump OFF</b>        |
| <b>A5, 1-speed P1 w/Circ</b> | <b>A10, Low Amp mode</b>        |

## GS50x Compatible

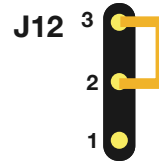

## J43



Memory  
Reset

### DIP Switch Key

- A1 ..... Test Mode (normally Off)
- A2 ..... In "ON" position, Button layout will be: Jets, Light, Down, Up  
..... In "OFF" position, Button layout will be: Unused, Jets, Temp, Light
- A3 ..... In "ON" position, use Mini Panel  
..... In "OFF" position, use Digital Duplex or Light Duplex panel
- A4 ..... Aux Freeze (must be OFF)
- A5 ..... In "ON" position, Two-speed pump 1  
..... In "OFF" position, One-speed pump 1 (A9 must be On and a circ pump installed)
- A6 ..... In "ON" position, 50Hz operation  
..... In "OFF" position, 60Hz operation
- A7 ..... In "ON" position, Standard mode only  
..... In "OFF" position, Std/Ecn/Sleep mode changes allowed
- A8 ..... In "ON" position, temperature is displayed in degrees Celsius  
..... In "OFF" position, temperature is displayed in degrees Fahrenheit
- A9 ..... In "ON" Position, 24 Hour Circ Pump with 3°F shut off  
..... In "OFF" position, no circ pump
- A10 ..... In "ON" Position, heater is disabled while any high-speed pump or blower is running (low amperage mode)  
..... In "OFF" position, heater can run while any/all high-speed pumps or blowers are running (high amperage mode)

\* No blower or second pump available on GS500Z models. If additional output is required, use GS501Z or higher.

### Jumper Key

- J12** Jumper on Pin 1 and 2 will enable GS51x/GS5xxS/GS5xxD compatibility mode.  
Jumper on Pin 2 and 3 will enable GS50x compatibility mode (Do not use with Serial or Deluxe Panels).
- J43** When jumper is placed on 2 pins during power-up, system will reset persistent memory.  
Leave on 1 pin only to enable persistent memory feature.

# Ozone Connections

*Note: A special tool is required to remove the pins from the connector body once they are snapped in place. Check with your Balboa Account Manager for information on purchasing a pin-removal tool.*

## Balboa Ozone connector configuration for 230VAC 50Hz:

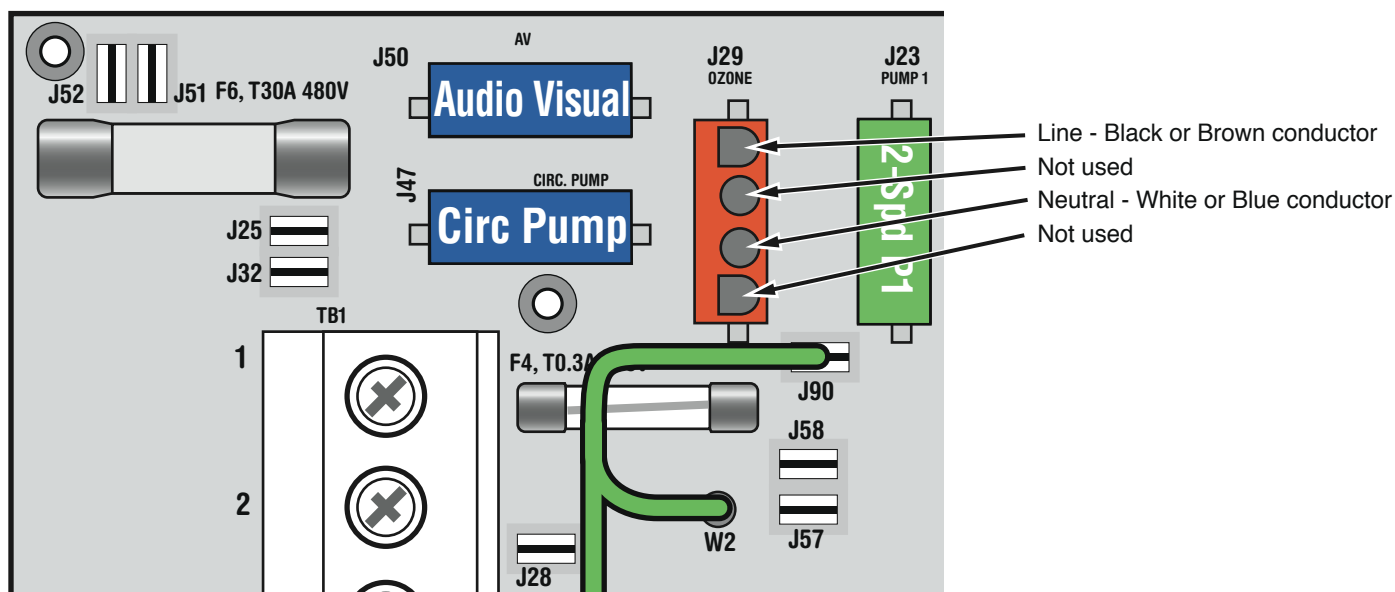
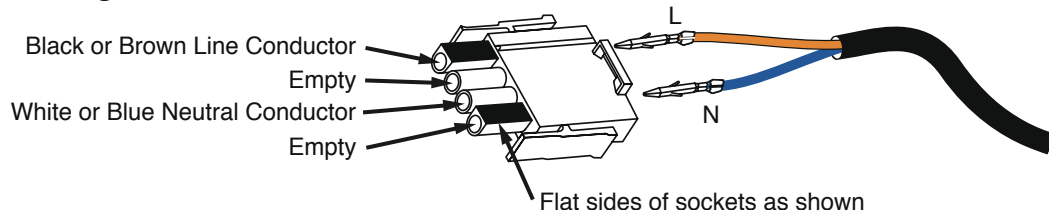



# Duplex Panel Configurations



Mini Panel

PN 52144 with Overlay PN 11095

- Connects to Main Panel terminal J1

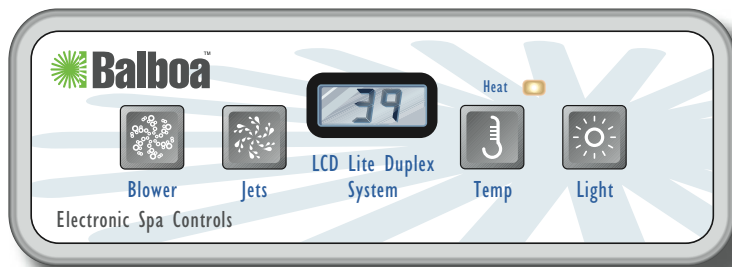

Lite Digital

PN 54094 with Overlay PN 10669

- Connects to Main Panel terminal J1

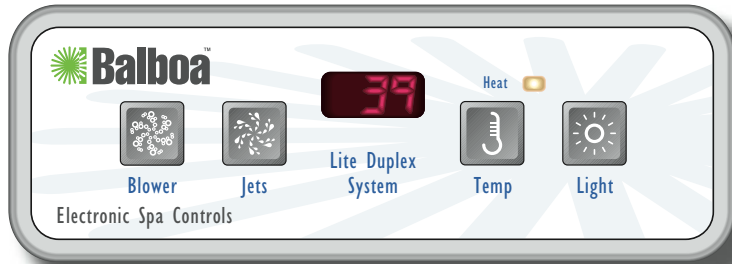

Lite Duplex

PN 51676 with Overlay PN 10671

- Connects to Main Panel terminal J1